

BAXI

User's Operating Instructions



Bioflo

Pellet Central Heating System Boiler

These instructions should be read in conjunction with the
Supplementary Instructions

Please keep these instructions in a safe place.
If you move house, please hand them over to the next occupier.

Baxi Bioflo 12 kW Granite
Baxi Bioflo 12 kW Pearl

© Baxi Heating UK Ltd 2010 All rights reserved. No part of this publication may be reproduced or transmitted in any form or by any means, or stored in any retrieval system of any nature (including in any database), in each case whether electronic, mechanical, recording or otherwise, without the prior written permission of the copyright owner, except for permitted fair dealing under Copyrights, Designs and Patents Act 1988.

Applications for the copyright owner's permission to reproduce or make other use of any part of this publication should be made, giving details of the proposed use, to the following address:

The Company Secretary, Baxi Heating UK Ltd,
Brooks House, Coventry Road, Warwick. CV34 4LL

Full acknowledgement of author and source must be given.

WARNING: Any person who does any unauthorised act in relation to a copyright work may be liable to criminal prosecution and civil claims for damages.

InfoWIN operating unit

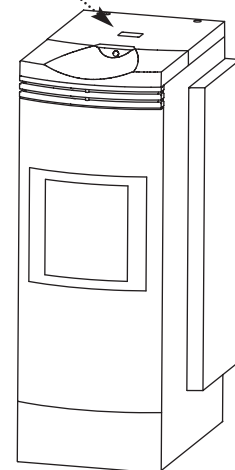

Important information for system operators 4

1.1	Safety precautions	4
1.2	Fuel	4
1.3	Start-up and maintenance	5
1.4	Checking the heating water	5
1.5	Operating noises	5
1.6	Filling the pellet store	6
1.7	Sources of danger	7
1.7.1	Fire protection	7
1.7.2	Power failure (or if the blower is not running)	7
1.7.3	Burner pot	7
1.7.4	Entering the pellet storage room, storage container	7

Operation 8

2.1	Functional description, function elements and operating controls	8
2.1.1	FireWIN Klassik	8
2.1.2	FireWIN Premium	9
2.1.3	FireWIN Exklusiv	9
2.1.4	Heat shield (accessory FIRE 023)	10
2.2	Check before initial start-up	11
2.3	Filling the reserve supply container	11
2.3.1	FireWIN Klassik – Manual filling	11
2.3.2	FireWIN Premium and Exklusiv – fully automatic filling	11
2.4	InfoWIN	12
2.5	Operating modes	13
2.5.1	OFF mode	13
2.5.2	ON mode, lighting ON, self-test, lighting OFF	13
2.5.3	Pellet feed	14
2.5.4	Solid fuel/buffer mode	14
2.5.5	Manual operation	15
2.5.6	Flue cleaning function	16
2.5.7	Shutdown procedure	16
2.6	Operating phases	17
2.6.1	Standby	17
2.6.2	Purging	17
2.6.3	Ignition phase	17
2.6.4	Flame stabilisation	17
2.6.5	Modulation mode	17
2.6.6	Burnout	17
2.6.7	Burner OFF	17
2.7	Information text	18
2.7.1	Next boiler cleaning	18
2.7.2	Operating hours	18
2.7.3	Pellet consumption total	19
2.7.4	Flue gas temperature	19
2.7.5	Boiler temperature setpoint	19
2.7.6	Current boiler output	19
2.7.7	Display module software version	19
2.7.8	Firing automate software version	19
2.7.9	Boiler model	19

Table of contents:

Page

2.8	Menu guide	.20
2.8.1	Operator level	.22
2.8.2	Service level	.37
2.9	Heating system operation	.38
2.9.1	FireWIN with MES system control	.38
2.9.2	FireWIN with REG standard control	.39

Care, cleaning and maintenance .41

3.1	Care of the front window, cladding and keyboard foil	.41
3.2	Cleaning and operating implements	.41
3.3	Overview of intervals between maintenance	.41
3.4	Heating surfaces	.43
3.5	Ash pan, ash on heating surface	.43
3.6	Combustion chamber	.44
3.6.1	Baffle plate, thermocontrol sensor	.44
3.6.2	Burner pot	.45
3.7	FireWIN reserve supply container	.46
3.8	Top heating surfaces and linkage	.48
3.9	Pressure measuring nipple, rotary feeder, blower wheel, blower box and exhaust pipe	.49
3.9.1	Pressure measuring nipple for combustion chamber pressure switch	.49
3.9.2	Rotary feeder	.49
3.9.3	Blower wheel, blower box and exhaust pipe to flue	.50

Troubleshooting .51

4.1	No display on InfoWIN	.52
4.2	Information messages	.52
4.3	Fault messages	.53
4.4	Alarm messages	.54

Declaration of conformity .58

Guarantee and warranty limitations .60

Important information for system operators

Dear Heating System Owners,

We would like to congratulate you on your new environmentally friendly boiler system. With the purchase of this high-quality product from WINDHAGER ZENTRALHEIZUNG, you have selected a system that provides more comfort and optimised fuel consumption while utilising an environmentally friendly means of saving resources. Your boiler was manufactured under strict ISO 9001 certified standards, was subjected to extensive tests and all its components are recyclable.

On the following pages we have provided specific information and important tips regarding system operation, unit functions and cleaning. Please pay close attention to these instructions. Familiarity with the material in this document will allow you to enjoy long-term operation of the unit. We wish you all the best with your WINDHAGER boiler!

Cordially,

WINDHAGER ZENTRALHEIZUNG

1.1 Safety precautions

The boiler and related accessories are state of the art and meet all applicable safety regulations.

Your boiler and all accessories operate using 230 V AC electric current. Improper installation or repair can pose the danger of life-threatening electric shock. Installation may be performed only by appropriately qualified technicians.

Caution symbols

Please take careful note of the following symbols in this Operating Manual.



Ignoring the warnings identified can lead to **personal injury**.



Ignoring the warnings identified can lead to **malfunction of or damage to the boiler or heating system**.

1.2 Fuel

The boilers are designed to burn the following fuels:

Pellets according to ÖNORM M7135 and DIN *plus*.

Significant criteria based on the standards are as follows:

Diameter 6 mm	Length 80% between 15 – 30 mm
Smooth surface	Density at least 1.1 kg/dm ³
Residual moisture content max. 10%	Energy content min. 18 MJ/kg = 5 kWh/kg (in water-free condition)
Ash content max. 0.5%	Abraded particles max. 2.3%
Chemical/synthetic binding agents are strictly prohibited	No impurities from varnish or paint residues, etc.

The pellets must be stored in a dry place so that they can be transported without problems and in order to achieve trouble-free operation with optimum combustion and at maximum efficiency.

Important information for system operators

1.3 Start-up and maintenance

Have Windhager Customer Service or one of our customer service PARTNERS put your new boiler into service. In this way, all functions of the new unit will be thoroughly checked; you will also benefit from the detailed information provided by the system installer. Installation by a qualified technician as well as the maintenance required by the guarantee limitations will guarantee the optimal use and service life of your boiler system. This is the only way to assure the benefits of this technologically advanced boiler and guarantee safe, environmentally friendly and energy-saving system operation.

The following preconditions must be met before you order the initial start-up:

- 1.) Boiler installed correctly.
- 2.) System fully wired up electrically.
- 3.) System rinsed, filled and vented – heat consumption must be possible.
- 4.) Hot water tank connected to domestic water and filled.
- 5.) Sufficient quantity of fuel available (pellets, split logs, oil or gas).
- 6.) The customer must be present during start-up.

The initial start-up cannot be carried out if any of these points are neglected. The customer will be charged for any unnecessary costs arising as a result. Start-up and maintenance are part of the guarantee requirements as listed in the enclosed „guarantee limitations“.

Note: During the first few weeks after start-up, condensation can occur in the combustion chamber, on the heating surfaces and in the ash pan. This has no effect on the function and service life of the boiler.

1.4 Checking the heating water

The chemical composition of the heating water must meet the specifications of ÖNORM H 5195 Part 1 or VDI 2035 T1. According to ÖNORM M 5195 Part 1, the condition of the heating water must be checked every 2 years by a heating technician in order to avoid corrosion and sediment accumulation in the heating system.

The check must be performed once every year in heating systems with more than 1500 litres of heating water.

In the event of repair work requiring a change of water in the heating system, the heating water is to be checked within 4 to 6 weeks after such work. Corrosion and sediment resulting from improper heating water are not covered by the guarantee and warranty.

1.5 Operating noises

The FireWIN is a modern, fully automated pellet central heating boiler for living areas with a high level of convenience in terms of operation and cleaning. This automation means that operating noises may occur during normal operation.

Normal operating noises are:

Flame noises – Natural flame noise can be heard depending on the size of the flames.

Light scratching and scraping noises – Depending on the level of contamination, cleaning noises may occur during automated cleaning or shake-out. If these become louder over time ⇒ Clean the pellet central heating boiler for living areas, especially the burner pot.

Trickling of pellets and vacuum cleaner noise – Fully automated pellet supply involves pellets being sucked from the storage room into the reserve supply container. During filling, the suction turbine generates a „vacuum cleaner noise“ in the storage room and the feed hose, and the trickling of the pellets can be heard in the reserve supply container.

Clicking noises – The relays switch on or off when the control unit is installed.

Liquid noise, gurgling – This is caused by air in the heating water ⇒ Bleed the system.

Air induction noises – Air induction noise occurs at the air supply induction point for combustion (air opening in the device) ⇒ Use air supply pipes to relocate the induction point outside the house or into an adjacent room.

Note: Due to these operating and flame noises, we do not recommend installing the device in bedrooms or quiet rooms – see also the information in the FireWIN installation instructions, „Installation“

Important information for system operators

1.7 Sources of danger

1.7.1 Fire protection

The entire system must comply with technical fire protection requirements in accordance with the applicable regulations, standards and guidelines.

All flammable materials in the close vicinity of the pellet central heating boiler for living areas must be protected against the effects of heat, in particular in the area of the front window.



Do not drape clothing or other items over the FireWIN for drying them.



Do not touch the front window – danger of burns.

1.7.2 Power failure (or if the blower is not running)



Do not open the combustion chamber door, there is an increased risk of deflagration when opening the combustion chamber door. A self-test is performed following a power failure during combustion and then operation is continued automatically.

1.7.3 Burner pot



Never fill the burner pot with pellets by hand. Excessive combustion material in the burner pot means that the pellets will not be ignited optimally. Too much low temperature carburisation gas will be generated and this can lead to deflagration.

1.7.4 Entering the pellet storage room, storage container

In certain conditions, higher concentrations of harmful gases (e.g. carbon monoxide) may build up in pellet storage rooms. If these are allowed to build up over long periods, it may present a hazard. Even though there is no risk under normal circumstances, this scenario cannot be completely ruled out.

- When working in filled pellet storage rooms, in the interests of safety a second person should always remain outside the storage room. Always air pellet stores thoroughly before entering.
- For stores that are difficult to access or only accessible from above (e.g. buried tanks), the person entering the store should use additional safety equipment.
- Keep children away from the pellet store!



Do not attempt to enter an unaired storage room (particularly buried tanks).

Operation

2.1 Functional description, function elements and operating controls

The FireWIN pellet central heating boiler for living areas and the Modular Energy System MES or the REG standard control combine to form a perfect unit. The FireWIN automatically fires when the control system signals a heating requirement. Following „purging“ (safety function), ignition starts and the pellet metering auger switches on. The burner pot is automatically filled with pellets. When flame formation has been detected (by the thermocontrol sensor), the boiler enters flame stabilisation mode and then control mode (modulation mode) and keeps to the specified boiler temperature setpoint (between 60 °C and 75 °C). The boiler enters burnout mode if the output drops below the minimum nominal thermal output or no heating requirement is signalled by the control system. The blower continues to run until the burner pot has cooled down. Therefore, do not switch off the electricity supply to the device too soon.

2.1.1 FireWIN Klassik

The reserve supply container is loaded by hand. The heating surfaces are cleaned manually using the cleaning lever. The cleaning residues from the heating surfaces and the combustion residues from the burner pot drop into the ash pan or ash pan space.

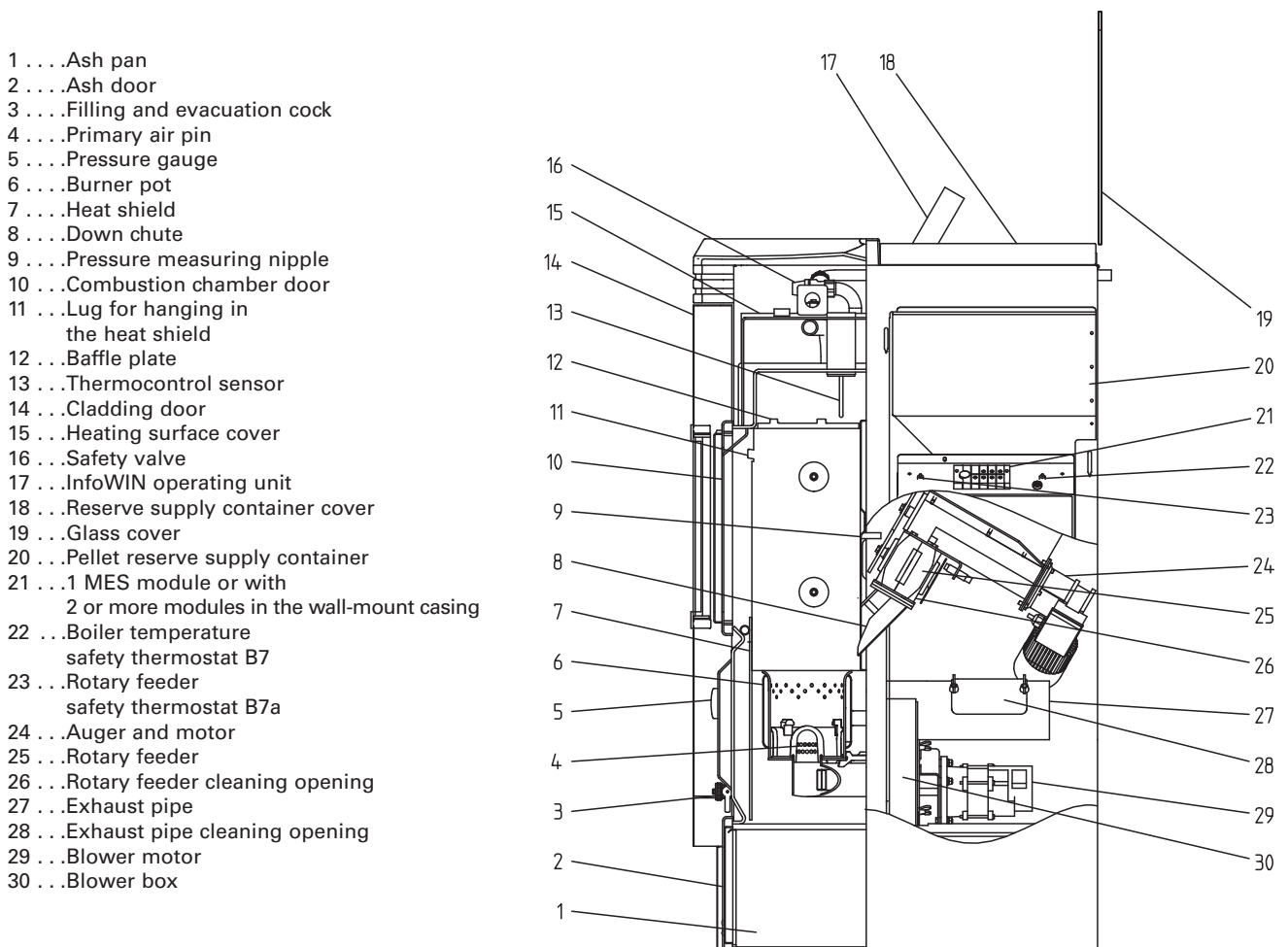

Fig. 3 FireWIN Klassik – view from right

Operation

2.1.2 FireWIN Premium

Version as FireWIN Klassik, but in addition with fully automated pellet feed

The pellet feed uses a maintenance-free suction turbine to fill the FireWIN reserve supply container fully automatically with pellets from a pellet storage room or storage container. The pellet feed is switched on by the lower fill level switch (proximity switch) in the reserve supply container or at the end of the enable time or the beginning of the start time, and runs for as long as the reserve supply container is full. Filling is not started if the boiler is in heating operation or the feed has been blocked by the control unit (outside the enable time, e.g. at night). If the boiler is operating when filling is necessary, the boiler switches to burnout mode.

Switching between suction probes 1, 2 and 3 is a fully automatic process. The system changes to the next suction probe after the reserve supply container has been filled a certain number of times. This means the storage room is emptied as evenly as possible.

- 1 ... Ash pan
- 2 ... Ash door
- 3 ... Filling and evacuation cock
- 4 ... Primary air pin
- 5 ... Pressure gauge
- 6 ... Burner pot
- 7 ... Heat shield
- 8 ... Down chute
- 9 ... Pressure measuring nipple
- 10 ... Combustion chamber door
- 11 ... Lug for hanging in the heat shield
- 12 ... Baffle plate
- 13 ... Thermocontrol sensor
- 14 ... Cladding door
- 15 ... Heating surface cover
- 16 ... Safety valve
- 17 ... InfoWIN operating unit
- 18 ... Reserve supply container cover
- 19 ... Glass cover
- 20 ... Inspection cover
- 21 ... Coarse filter
- 22 ... Pellet reserve supply container
- 23 ... 1 MES module or with 2 or more modules in the wall-mount casing
- 24 ... Boiler temperature safety thermostat B7
- 25 ... Rotary feeder safety thermostat B7a
- 26 ... Auger and motor
- 27 ... Rotary feeder
- 28 ... Rotary feeder cleaning opening
- 29 ... Exhaust pipe
- 30 ... Exhaust pipe cleaning opening
- 31 ... Blower motor
- 32 ... Blower box

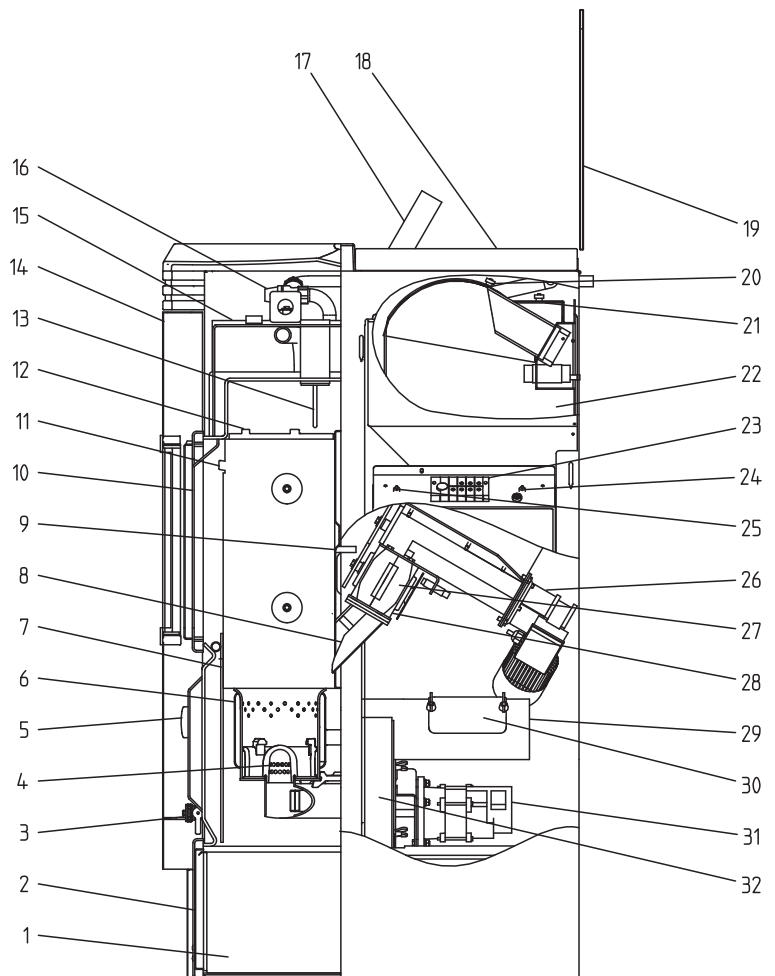

Fig. 4 FireWIN Premium – view from right

2.1.3 FireWIN Exklusiv

Version as FireWIN Premium, but in addition with fully automatic heating surface cleaning and ash compactor

Fully automatic heating surface cleaning:

A motor moves the heating surface cleaning system vertically and the heating surfaces remain clean.

Fully automatic ash compactor:

The fully automatic ash compactor uses a motor and pressure plate to compress the ash in the ash container. This makes the emptying intervals up to 3 times longer.

Operation

- 1 ... Ash pan
- 2 ... Ash door
- 3 ... Ash compactor
- 4 ... Filling and evacuation cock
- 5 ... Primary air pin
- 6 ... Pressure gauge
- 7 ... Burner pot
- 8 ... Heat shield
- 9 ... Down chute
- 10 ... Pressure measuring nipple
- 11 ... Combustion chamber door
- 12 ... Lug for hanging in the heat shield
- 13 ... Baffle plate
- 14 ... Thermocontrol sensor
- 15 ... Cladding door
- 16 ... Heating surface cover
- 17 ... Safety valve
- 18 ... InfoWIN operating unit
- 19 ... Reserve supply container cover
- 20 ... Glass cover
- 21 ... Inspection cover
- 22 ... Coarse filter
- 23 ... Pellet reserve supply container
- 24 ... 1 MES module or with 2 or more modules in the wall-mount casing
- 25 ... Boiler temperature safety thermostat B7
- 26 ... Rotary feeder safety thermostat B7a
- 27 ... Auger and motor
- 28 ... Rotary feeder
- 29 ... Rotary feeder cleaning opening
- 30 ... Exhaust pipe
- 31 ... Exhaust pipe cleaning opening
- 32 ... Blower motor
- 33 ... Blower box
- 34 ... Motor for ash compression

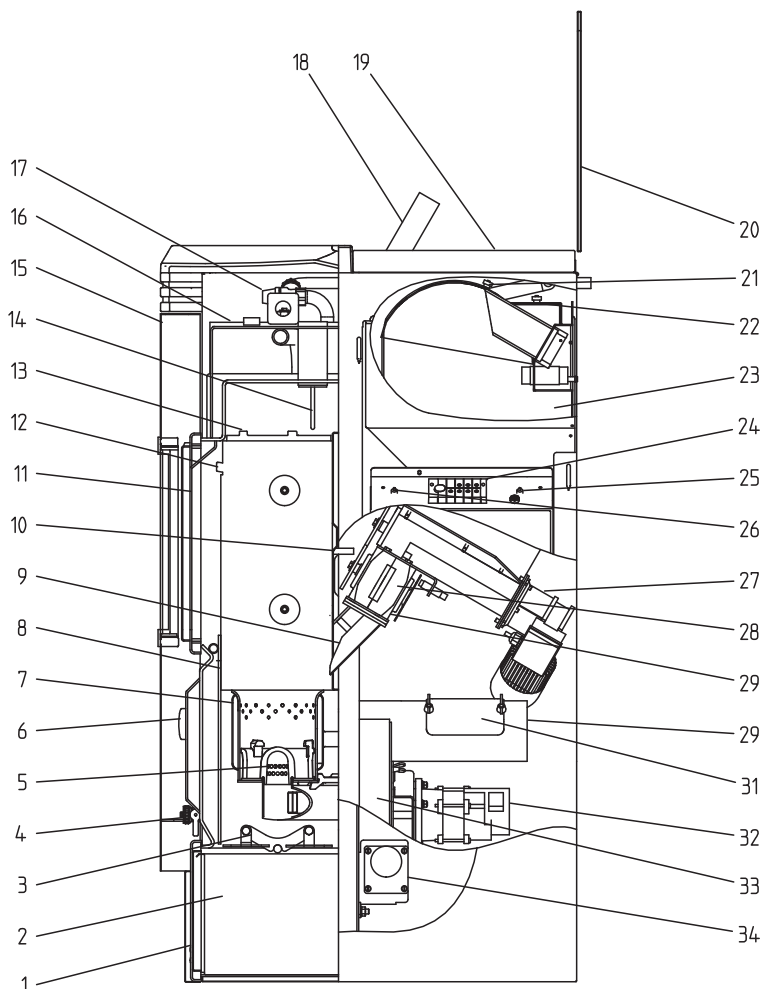

Fig. 5 FireWIN Exclusiv – view from right

2.1.4 Heat shield (accessory FIRE 023)

Heat radiated from the front window can lead to unwanted heating of the room where the unit has been set up when domestic hot water is being heated during the summer. If you do not want the room to be heated, you can significantly reduce the amount of heat radiated using the patented heat shield (accessory Fire 023).

The air-to-water ratio without a heat shield is approx. 15 : 85 % and with a raised heat shield approx. 9 : 91 %.

The heat shield is located in the combustion chamber. This can be pulled up using the supplied Allen key and hooked into the lugs on the sides of the combustion chamber cover plates, Figs. 6, 7.



Fig. 6 Hooking in the Allen key



Fig. 7 Pulling up the heat shield and hooking it into the lugs on the sides

Operation

2.2 Check before initial start-up

a) System pressure (heating water pressure):

The system must be filled and vented. With the system cold, pressure should be at least 1.0 bar (maximum 1.8 bar) – Fig. 8 If you have any questions, your installer will gladly answer them.

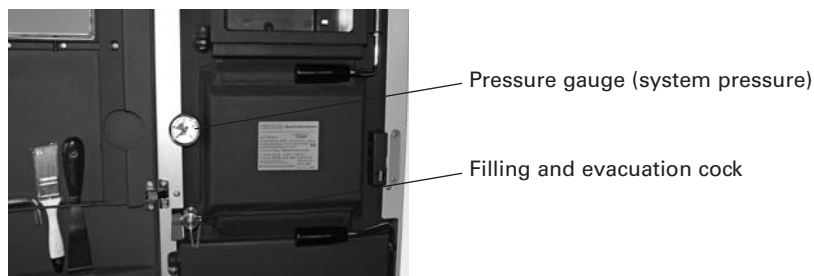

Fig. 8 Filling the system

b) Ventilation:

If you are operating the device with room air, please make sure the room where it is installed is well ventilated. The air supply must be as free of dust as possible.

c) Flue:

Please have the chimney sweep check the flue, and, if necessary, clean it.

2.3 Filling the reserve supply container

2.3.1 FireWIN Klassik – Manual filling

Note: Do not open the reserve supply container cover unless the glass cover is closed, in order to avoid damaging the glass cover.

Fold open the cover of the reserve supply container (Fig. 9) and fill the reserve supply container up to max. 1 cm below the edge. Close the cover.

Tip: The reserve supply container should always be completely filled with pellets. This allows the incoming pellets to drop into the container better, reduces the size of the conical part of the pile and means that the container empties better.



When filling, make sure no extraneous materials (e.g. shreds of the pellet bags resulting from cutting open the bags) enter the reserve supply container – they could block the rotary feeder!



Fig. 9 Folding open the cover

2.3.2 FireWIN Premium and Exklusiv – fully automatic filling

The reserve supply container is filled by the fully automatic pellet feed. WINDHAGER Customer Service or the customer service PARTNER will perform the first fill (start-up), take the boiler and its pellet supply into service and familiarise the customer with the operation and cleaning of the boiler, with reference to the Operating Manual.

Operation

2.4 InfoWIN

The InfoWIN is located at the top under the glass cover. Press the locking button at the front and fold the glass cover open, the InfoWIN pops up automatically – Figs. 10, 11. It consists of a large full text display, an ON/OFF button with an LED signal lamp indicating Operation (green) or Malfunction (red), a button for manual operation / flue cleaning function as well as four individual menu buttons. The function of each menu button is displayed on the Menu line.



Fig. 10 Press the locking button



Fig. 11 InfoWIN pops up

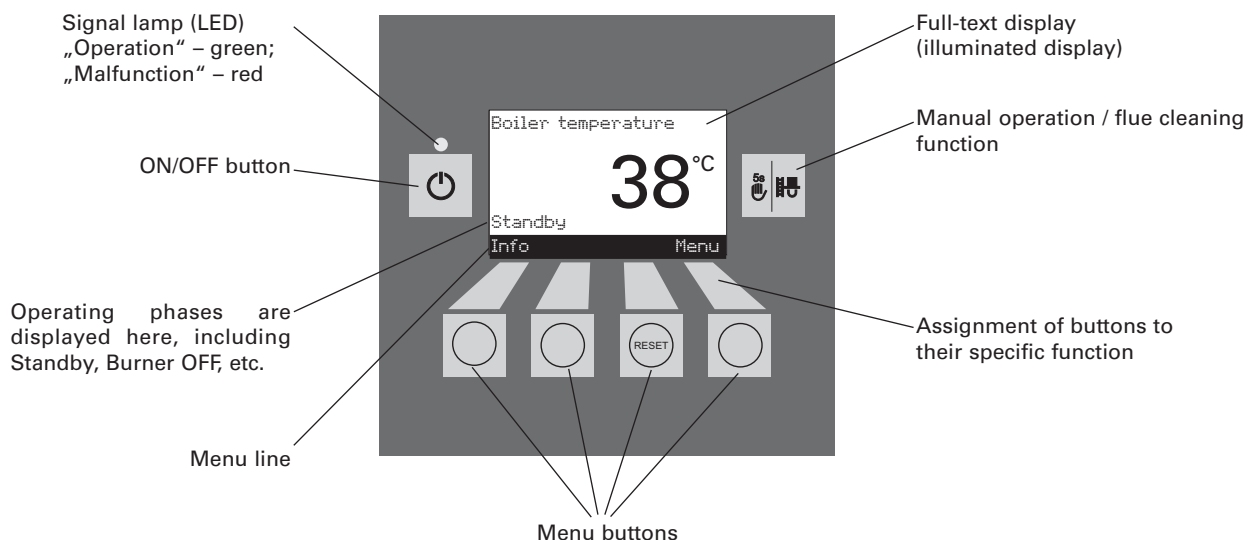

Fig. 12 InfoWIN

The various operating modes are displayed on InfoWIN together with the corresponding operating phases.

The following **operating modes** exist:

- OFF
- ON (with self-test, lighting ON, lighting OFF)
- Pellet feed
- Solid fuel / buffer mode
- Manual operation
- Flue cleaning function
- Shutdown procedure



Corresponding **operating phases**:

- Standby
- Purging
- Ignition phase
- Flame stabilisation
- Modulation mode
- Burnout
- Burner OFF
- Switch off heat generator

Operation

2.5 Operating modes

2.5.1 OFF mode

The boiler is switched off when in OFF mode. The display and all buttons, with the exception of the *ON/OFF* button, do not function. The LED on the InfoWIN is not illuminated – Fig. 13.

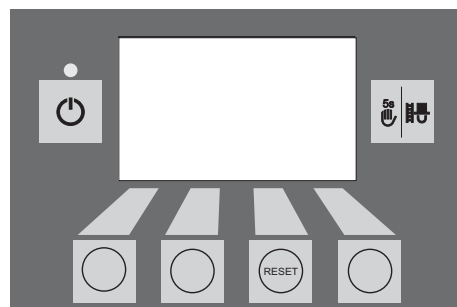

Fig. 13 OFF mode

2.5.2 ON mode, lighting ON, self-test, lighting OFF

Press the *ON/OFF* button, lighting and display are switched on and the self-test starts automatically – Fig. 14.

Self-test:

Sensors, switches and motors are checked during the self-test.

After a successful self-test, the display shows an operating phase and the boiler water temperature (standard display). The LED signal lamp lights green and the desired functions can be selected using the buttons – Fig. 15.

If the self-test was unsuccessful, an information message (e.g. information, fault, alarm) is displayed (see sections 4.3 and 4.4).

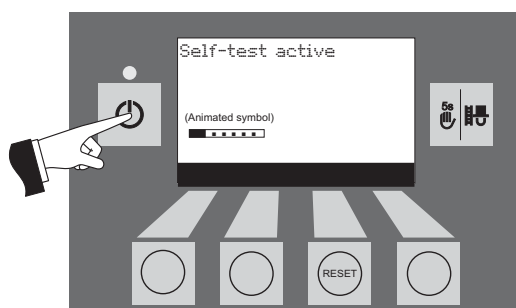

Fig. 14 Self-test

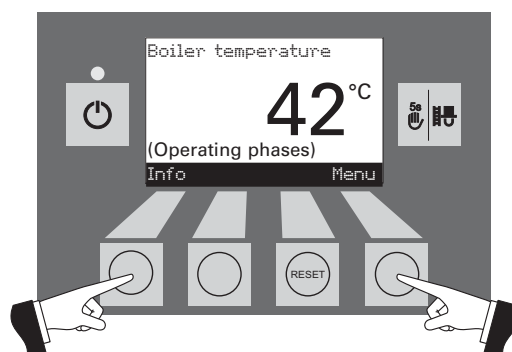

Fig. 15 Standard display

Lighting ON/OFF

The display lighting switches off automatically after 10 min. (Fig. 16). Pressing one of the six buttons switches the lighting on again for 10 min.

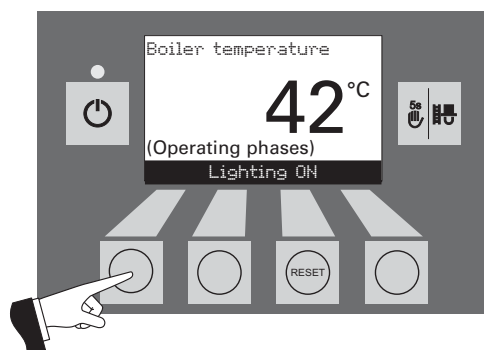

Fig. 16 Display lighting OFF

InfoWIN identifies and stores the various operating modes and states. Once the system is switched on, other operating modes may also be displayed instead of the standard display, such as manual operation or solid fuel/buffer mode; malfunctions are also displayed. These operating modes and states are described later in these instructions.

Operation

2.5.3 Pellet feed

Pellet feed – Burnout

Pellet feed from the storage room into the reserve supply container has been requested. Combustion is stopped. Pellet transport into the burner pot is stopped, the vacuum fan continues to run until all the remaining pellets have been burned and the burner pot has cooled down. – Fig. 17



Fig. 17

Pellet feed in operation

The pellet feed is in operation. Pellets are supplied from the storage room into the reserve supply container. The burner is locked – Fig. 18.



Fig. 18

2.5.4 Solid fuel/buffer mode

If the FireWIN pellet central heating boiler for living areas is combined with a solid fuel boiler or an buffer tank, the WVF or BUL module automatically switches over between pellet and solid fuel/buffer mode.

Combustion of the FireWIN is stopped when the WVF or BUL module sends the request to switch over to solid fuel/buffer mode – Fig. 19.

Following this, the system switches over to solid fuel/buffer mode and the FireWIN burner is locked – Fig. 20

If the pellet central heating boiler for living areas is switched off using the ON/OFF button on the InfoWIN, an automatic switchover to solid fuel/buffer mode is performed in conjunction with a WVF module. Once the InfoWIN unit is switched on, the pellet central heating boiler may be locked for a maximum of 15 minutes due to the switch-over delay. This is displayed by InfoWIN – Fig. 20.

After an hour in solid fuel/buffer mode, the display is shut down fully and only the green LED is lit up. The display is switched back on by pressing a button or when there is a heating requirement.

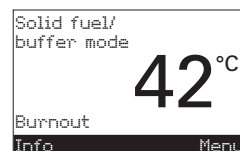

Fig. 19

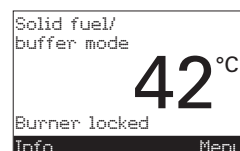

Fig. 20

Operation

2.5.5 Manual operation

Note: Manual operation cannot be started in „solid fuel/buffer mode“. Manual operation must not be started if an installed solid fuel boiler is operating (heated up). Manual operation may be started if there is no solid fuel boiler installed or if this is not operating and only the buffer tank is active. In this case, first set the operating mode switch on the WVF module to relay test 2 or on the BUL module to relay test 1 (see WVF or BUL module operating manual).

Pressing one of the six buttons switches the lighting and display on. Manual operation starts if the Manual operation / flue cleaning function button is pressed for more than five seconds – Fig. 21. This sets the boiler temperature to the setpoint fixed for manual operation (standard value 60 °C). The control system is not affected by this. The lighting is switched off after the lighting timer has counted down (10 min.); the function or display remains unchanged.

The various operating phases are displayed here, including Burner in operation, Burner OFF, etc.

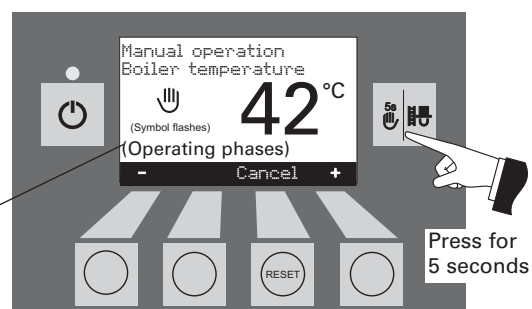

Pressing the *Cancel* button or the *Manual operation / flue cleaning function* button terminates the function – Fig. 22. The boiler returns to automatic operation.

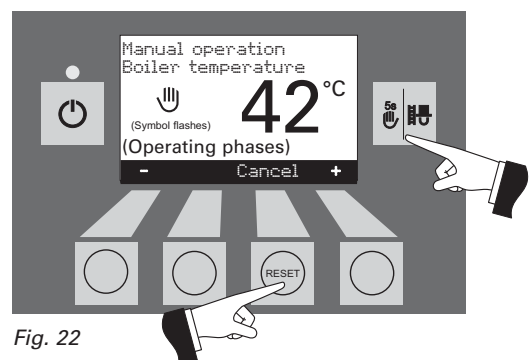

Setpoint adjustment for manual operation

By pressing the *+* or *-* button the display switches to the set temperature adjustment mode – Fig. 23. Use the *+* or *-* button to change the setpoint in 1 K steps. The temperature set in this mode is not permanently saved. The original set temperature is used once manual operation ends.

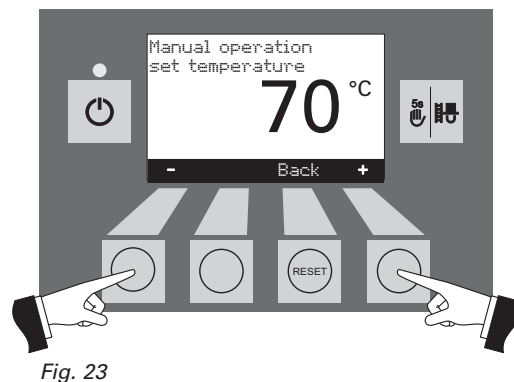

By pressing the *Back* button (Fig. 24) or after waiting 45 seconds, the screen returns to its previous display.

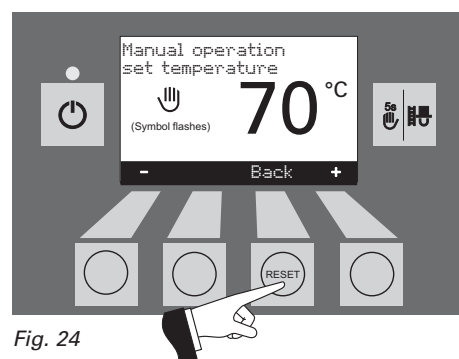

Operation

2.5.6 Flue cleaning function

This function aids the performance of legally-required emissions testing.

Note: The flue cleaning function cannot be started in „solid fuel/buffer mode.“The flue cleaning function must not be started if an installed solid fuel boiler is operating (heated up). The flue cleaning function may be started if there is no solid fuel boiler installed or if this is not operating and only the buffer tank is active. In this case, first set the operating mode switch on the WVF module to relay test 2 or on the BUL module to relay test 1 (see WVF or BUL module operating manual).

Briefly pressing the *Manual operation / flue cleaning function* button switches on the display illumination. Pressing the button again starts the flue cleaning function – Fig. 25. The boiler temperature is set to approx. 60 °C for 45 min.

The various operating phases are displayed here, including Burner in operation, Burner OFF, etc.

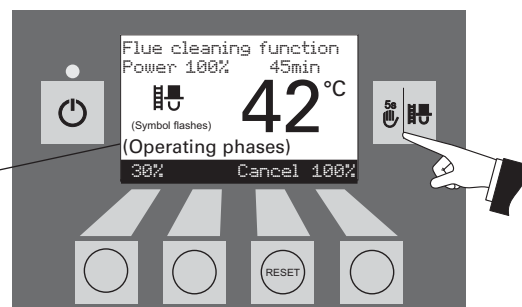

Fig. 25

Pressing the corresponding menu button enables the boiler to be operated with 30 % or 100 % output – Fig. 26. The lighting is switched off after the lighting timer has counted down (10 min); the function or display remains unchanged. When the button is first pressed only the lighting is switched on.

When the *Manual operation / flue cleaning function* button is pressed again the operating time is reset to 45 min.

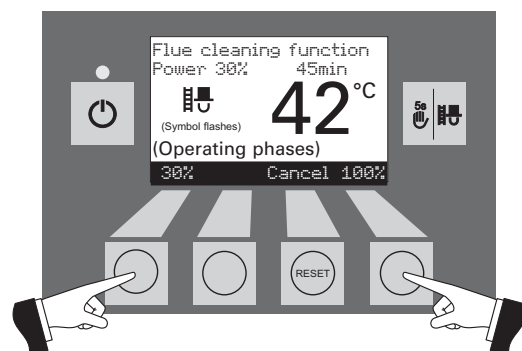

Fig. 26

The flue cleaning function ends

- when the *Cancel* button is pressed – Fig. 27.
- automatically after about 45 minutes.

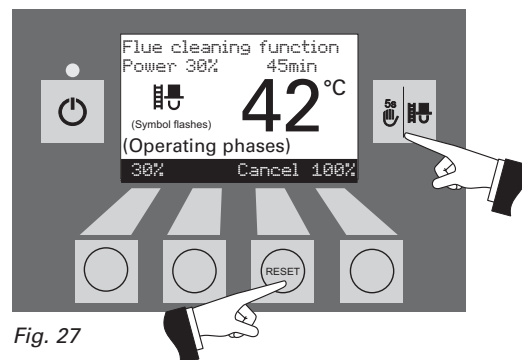

Fig. 27

2.5.7 Shutdown procedure

The boiler is switched off – Fig. 28.

The green LED flashes

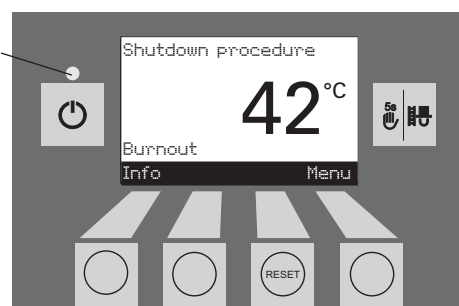

Fig. 28

Operation

2.6 Operating phases

2.6.1 Standby

During this operating phase, the control system does not transmit requests for heat. The burner is switched off and the boiler temperature setpoint is 0 °C – Fig. 29.

After an hour in standby mode, the display is shut down fully and only the green LED is lit up. The display is switched back on by pressing a button or when there is a heating requirement.

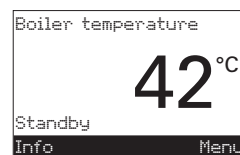

Fig. 29

2.6.2 Purging

The vacuum fan runs, the combustion chamber of the FireWIN is flushed through with fresh air. This phase can last several minutes before the burner fires – Fig. 30.

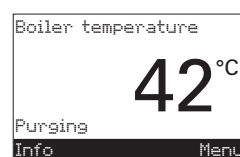

Fig. 30

2.6.3 Ignition phase

The vacuum fan runs, pellets are transported into the burner pot and are ignited. When flame formation is detected, the system switches over to flame stabilisation – Fig. 31.

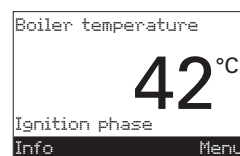

Fig. 31

2.6.4 Flame stabilisation

Following the ignition procedure, uniform combustion is established and then the system switches over to modulation mode – Fig. 32.

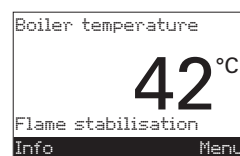

Fig. 32

2.6.5 Modulation mode

The burner is in modulation mode. The output can be infinitely varied between 30 % and 100 % – Fig. 33.

Note: In the modulation mode briefly no flame can be visible during the automatic burner ash removal!

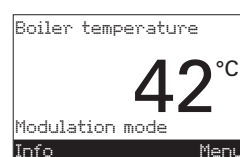

Fig. 33

2.6.6 Burnout

Combustion is stopped. Pellet transport into the burner pot is stopped, the vacuum fan continues to run until all the remaining pellets have been burned and the burner pot has cooled down – Fig. 34.

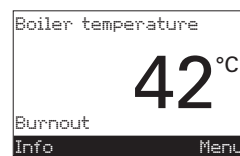

Fig. 34

2.6.7 Burner OFF

There is a heating requirement from the control system, but the boiler temperature (actual value) is higher than the boiler temperature setpoint. This means combustion is stopped and the burner is switched off – Fig. 35.

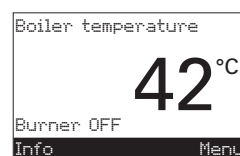

Fig. 35

Operation

2.7 Information text

Pressing the *Info* button calls up the most important FireWIN information – Fig. 36.

The *arrow* buttons select and display sub-menus – Fig. 37. By pressing the *Back* button (Fig. 38) or waiting 45 seconds, the screen returns to the standard display.

The following **information texts** exist:

- Next boiler cleaning in about[h]
- Operating hours [h]
- Pellet consumption total [t]
- Flue gas temperature [°C]
- Boiler temperature setpoint [°C]
- Current boiler output [%]
- Display module software version
- Firing automate software version
- Boiler model

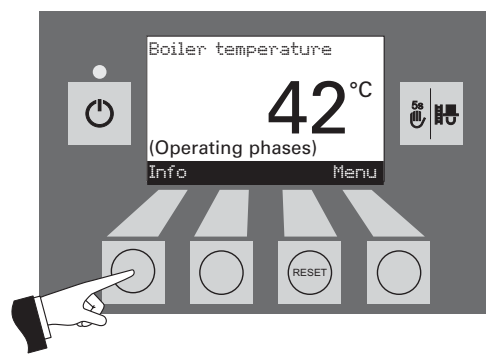

Fig. 36

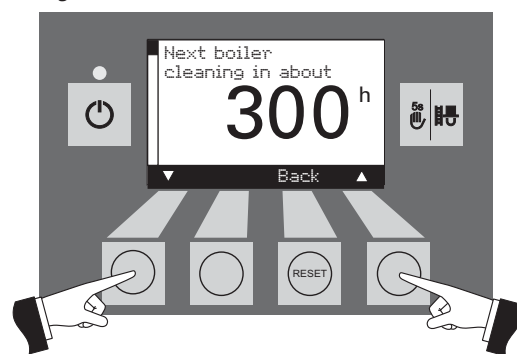

Fig. 37

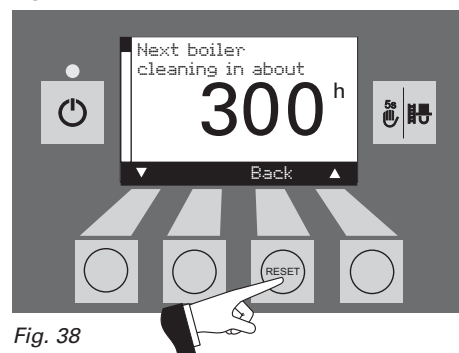

Fig. 38

2.7.1 Next boiler cleaning

Display showing the operating time in hours remaining until the next boiler cleaning – Fig. 39.

Note: The operating time remaining until the next boiler cleaning depends on the operating method and is constantly recalculated. Therefore, there may be deviations from the normal operating hours.



Fig. 39

2.7.2 Operating hours

The total number of burner operating hours is displayed – Fig. 40

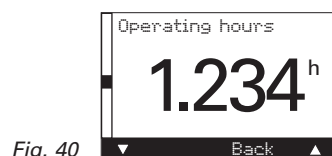

Fig. 40

Operation

2.7.3 Pellet consumption total

The total amount of pellets consumed is displayed in tonnes – Fig. 41.

Note: The „Pellet consumption total“ is a calculated value and can differ from the actual value by $\pm 15\%$.



Fig. 41

2.7.4 Flue gas temperature

If a flue gas temperature sensor (accessory) is connected, this function displays the current flue gas temperature – Fig. 42.

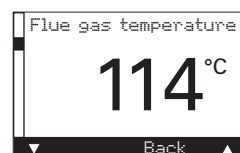

Fig. 42



The flue gas temperature is measured directly on the flue outlet. It may therefore deviate from a standard measurement.

2.7.5 Boiler temperature setpoint

The display indicates the boiler temperature setpoint as calculated by the control system. This setpoint is used to control the burner – Fig. 43.

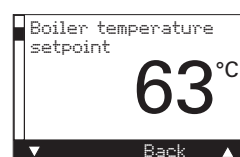

Fig. 43

2.7.6 Current boiler output

The current boiler output is displayed in %. The boiler output (modulation mode) can be set from 30 % to 100 % – Fig. 44.

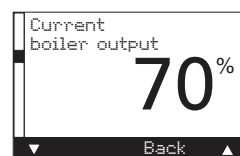

Fig. 44

2.7.7 Display module software version

The current software version of the display module (InfoWIN) is displayed – Fig. 45.



Fig. 45

2.7.8 Firing automate software version

The current software version of the firing automate (main PCB) is displayed – Fig. 46.



Fig. 46

2.7.9 Boiler model

The boiler model of the FireWIN is displayed – Fig. 47.



Fig. 47

Operation

2.8 Menu guide

Pressing the *Menu* button changes the menu display to operator level or service level – Fig. 48.

Use the *arrow* buttons to select the operator level or service level (Fig. 49) and confirm with the *Choose* button – Fig. 50.

The menu item or sub-menu item is exited by pressing the *Back* button (Fig. 51) or after a delay of 45 seconds.



Only trained service personnel may perform system modifications in the service level.

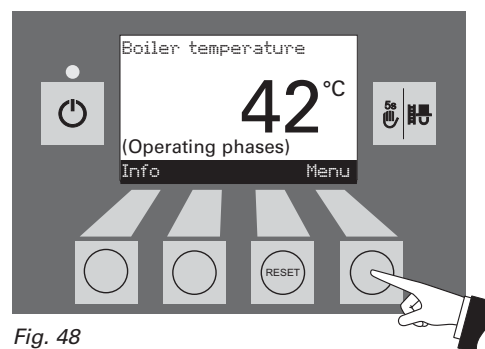

Fig. 48

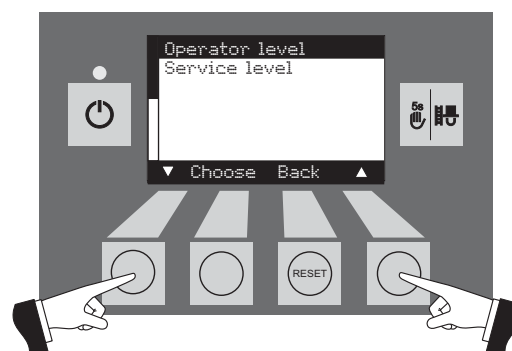

Fig. 49

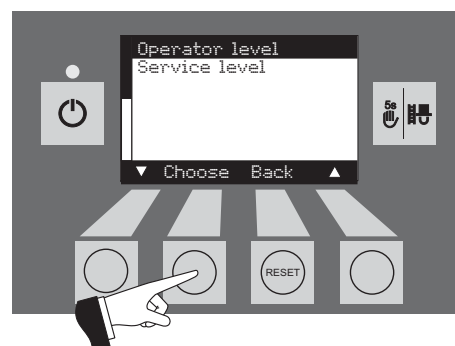

Fig. 50

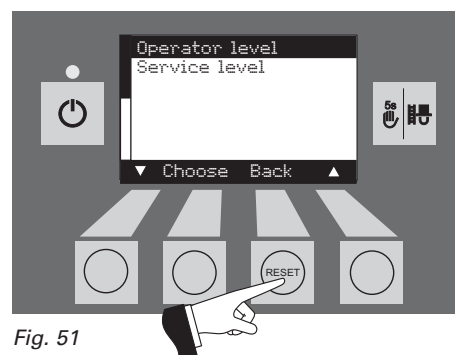
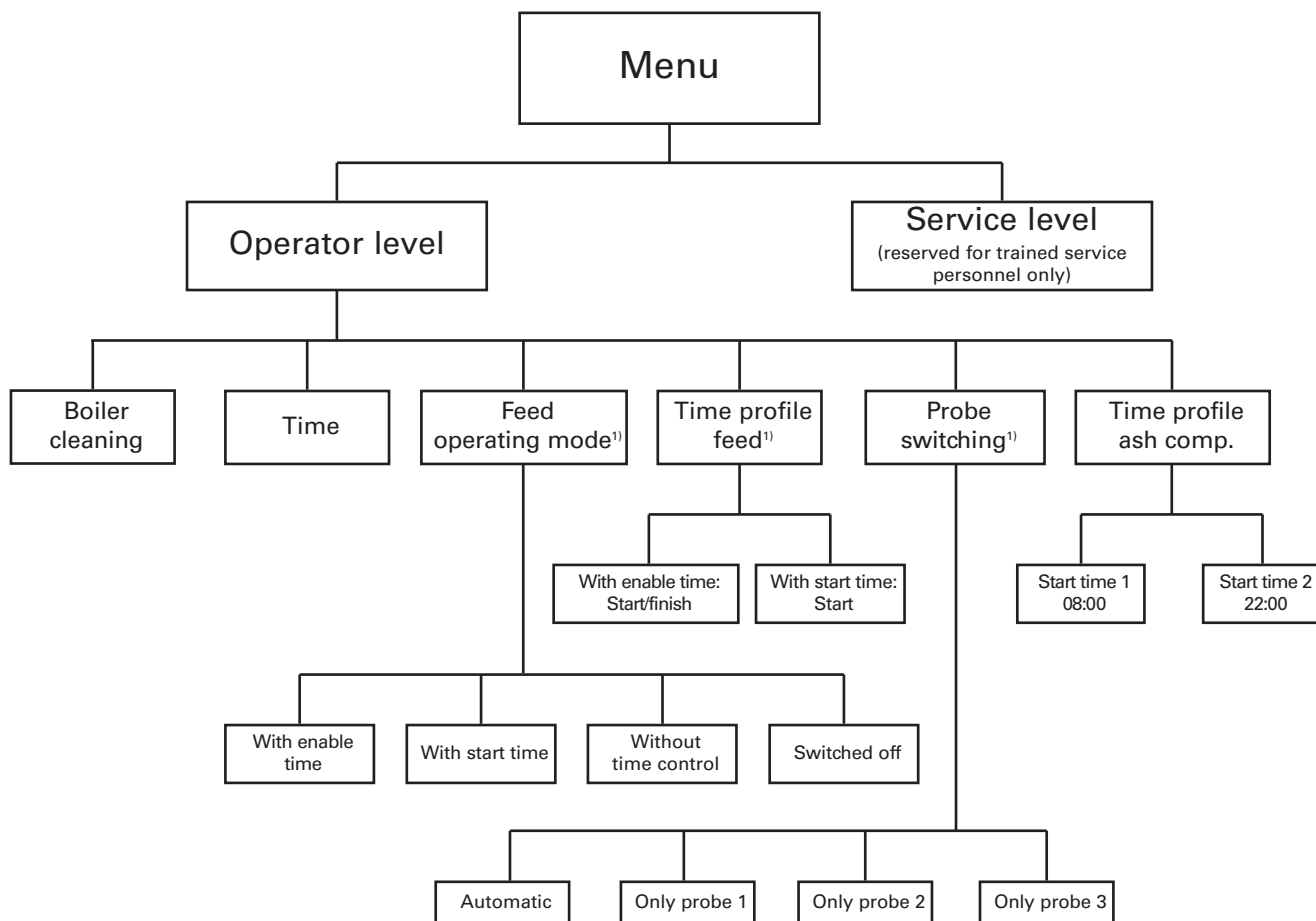

Fig. 51

Operation

Menu structure:



¹⁾ Only displayed if a feed system is present and if this has been adjusted by a trained service technician in the service level.

Operation

2.8.1 Operator level

Pressing the *Menu* button changes to the „Operator level“ and „Service level“ – Fig. 52.

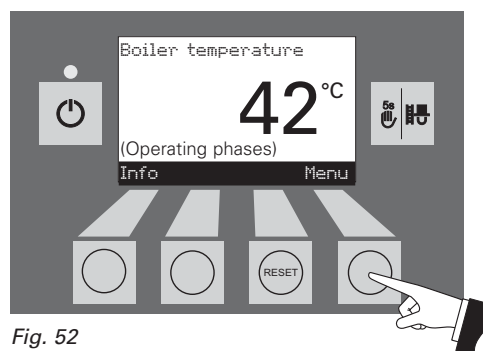

Fig. 52

Use the *arrow* buttons to select „Operator level“ and confirm with the *Choose* button – Fig. 53.

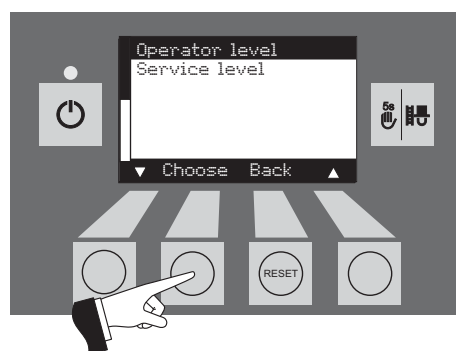

Fig. 53

In the operator level, use the *arrow* buttons to select the required sub-menu (Fig. 54) and confirm with the *Choose* button.

Adjusting the:

Boiler cleaning: 2.8.1.1

Time: see section 2.8.1.2.

Feed operating mode: see section 2.8.1.3.

Time profile feed: see section 2.8.1.4.

Probe switching: see section 2.8.1.5.

Time profile ash compression : see section 2.8.1.6

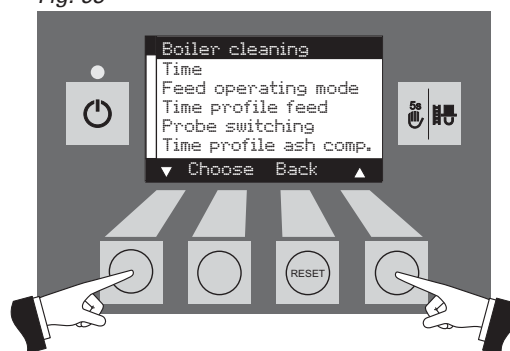

Fig. 54

Note: The menu items „Feed operating mode“, „Time profile feed“ and „Probe switching “ are only shown if a feed or probe switching function is provided and activated in the service level.

The menu item or sub-menu item is exited by pressing the *Back* button (Fig. 55) or after a delay of 45 seconds.

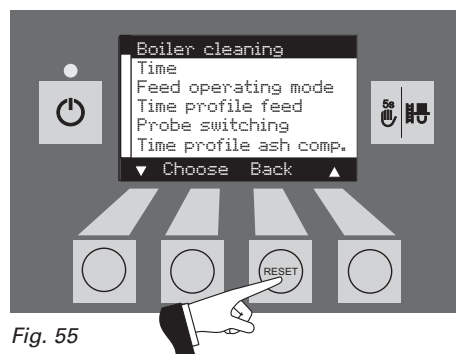

Fig. 55

Operation

2.8.1.1 Boiler cleaning - Resetting the cleaning request

After boiler cleaning has been performed (section 3.1), boiler cleaning must be confirmed so that the operating time until the next boiler cleaning is restarted.

i **Boiler cleaning must not** be reset if cleaning has not been carried out.

Pressing one of the six buttons switches the lighting and display on – Fig. 56.

Press the *Menu* button – Fig. 57.

Confirm the selected menu item „Operator level“ by pressing the *Choose* button – Fig. 58.

Use the *arrow* buttons to select the „Boiler cleaning“ sub-menu item – Fig. 59.

Confirm the selected „Boiler cleaning“ sub-menu item by pressing the *Choose* button – Fig. 60.

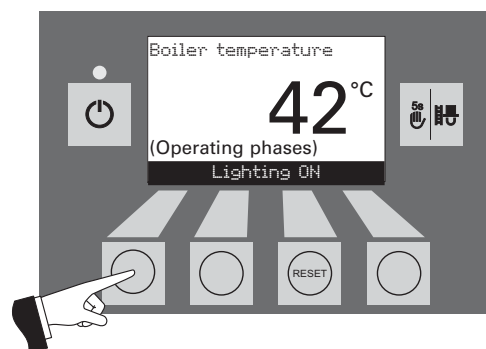

Fig. 56

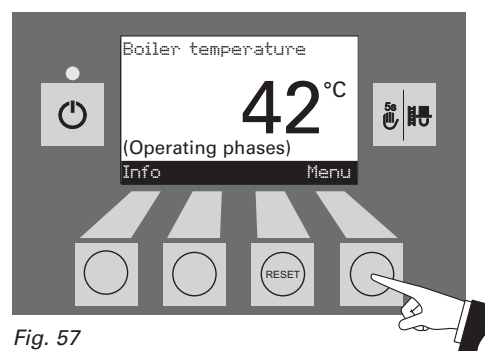

Fig. 57



Fig. 58

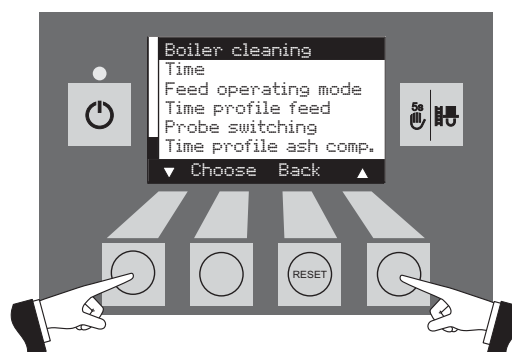

Fig. 59

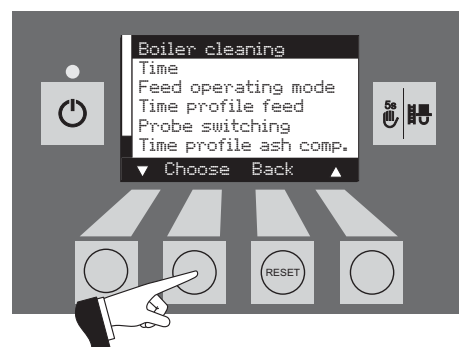

Fig. 60

Operation

Pressing the *Yes* button resets the boiler cleaning – Fig. 61. The display shows „Parameter is saved“ for a few seconds (Fig. 62) and then changes back to the previous level – Fig. 63.

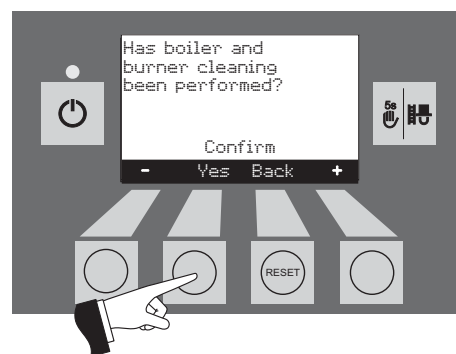

Fig. 61

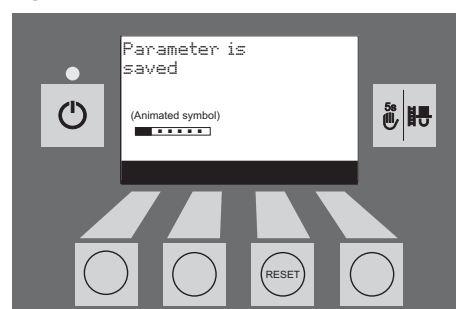

Fig. 62

The menu item or sub-menu item is exited by pressing the *Back* button (Fig. 63) or after a delay of 45 seconds.

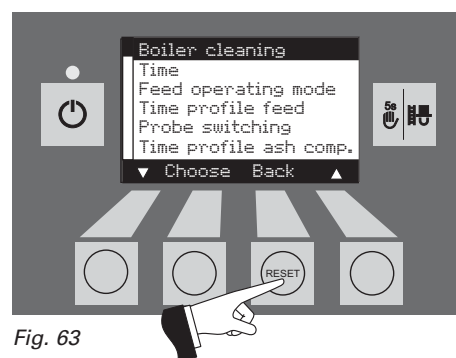

Fig. 63

Operation

2.8.1.2 Time

This time is used for the time control of the pellet feed, automatic heating surface cleaning and automatic ash compression.

If the FireWIN is operated with an MES control, the time is automatically adopted from the module and the time set here is overwritten.

If the FireWIN is operated with REG standard control, the time must be set here too.

Pressing one of the six buttons switches the lighting and display on – Fig. 64.

Press the *Menu* button – Fig. 65.

Confirm the selected menu item „Operator level“ by pressing the *Choose* button – Fig. 66.

Confirm the selected sub-menu item „Time“ by pressing the *Choose* button – Fig. 67.

Use the *arrow* buttons to set the required time – Fig. 68.

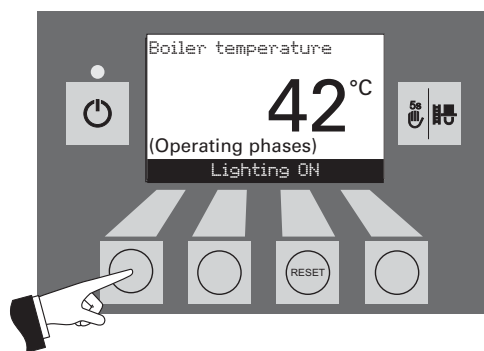

Fig. 64

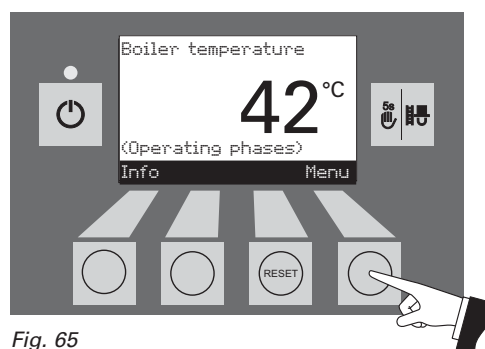

Fig. 65



Fig. 66

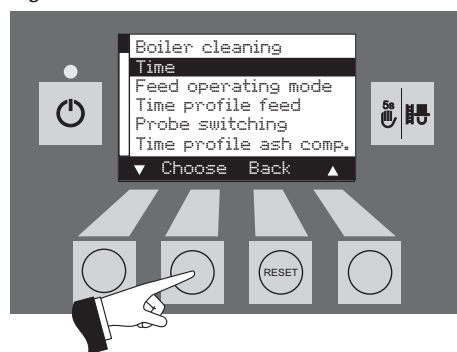

Fig. 67

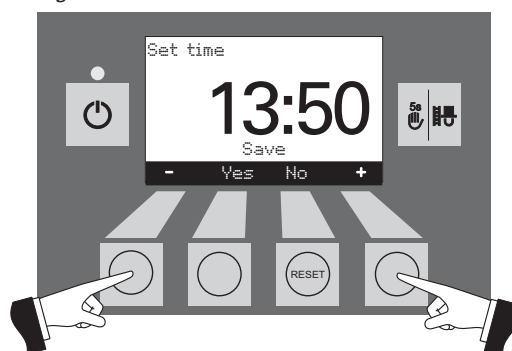

Fig. 68

Operation

Save the changed time by pressing the *Yes* button – Fig. 69. The display shows „Parameter is saved“ for a few seconds (Fig. 70) and then changes back to the previous level – Fig. 71.

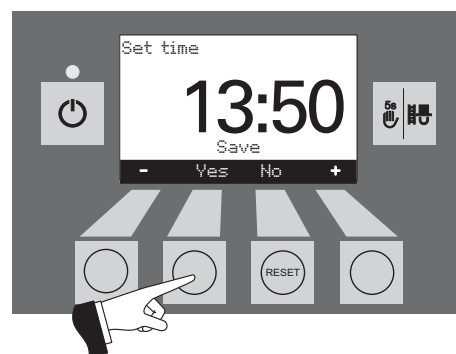

Fig. 69

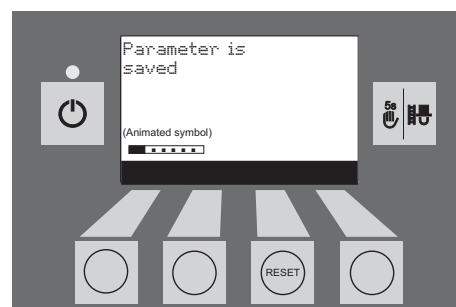

Fig. 70

The menu item or sub-menu item is exited by pressing the *Back* button (Fig. 71) or after a delay of 45 seconds.

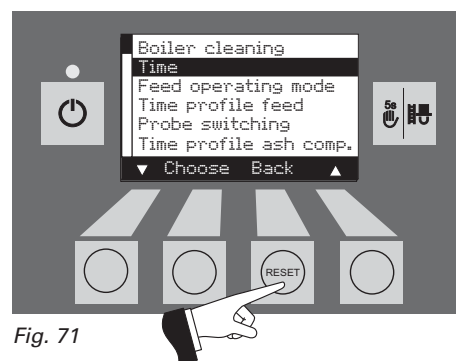

Fig. 71

Operation

2.8.1.3 Feed operating mode¹⁾

This menu item sets:

- whether the feed is switched off, or
- whether the feed should fill the pellet boiler with or without time control.

Pressing one of the six buttons switches the lighting and display on – Fig. 72.

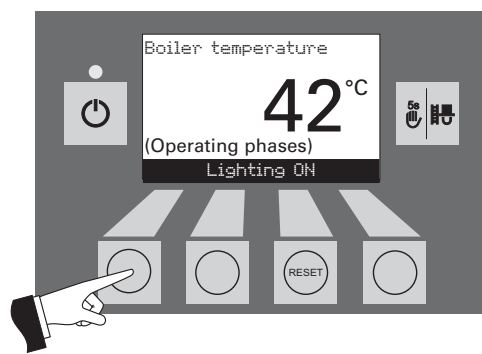

Fig. 72

Press the *Menu* button – Fig. 73.

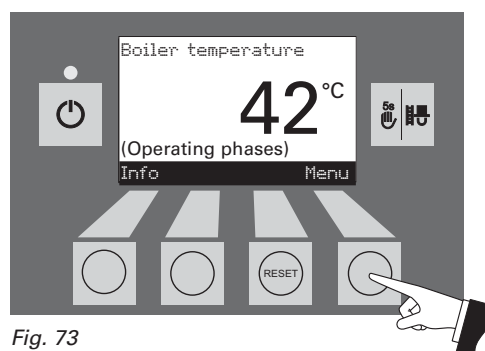

Fig. 73

Confirm the selected menu item „Operator level“ by pressing the *Choose* button – Fig. 74.

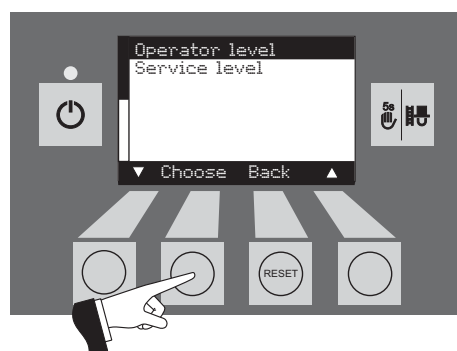

Fig. 74

Use the *arrow* buttons to select the sub-menu item „Feed operating mode“ – Fig. 75.

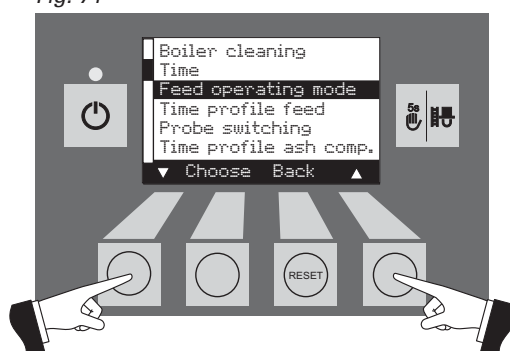

Fig. 75

Confirm the selected sub-menu item „Feed operating mode“ by pressing the *Choose* button – Fig. 76.

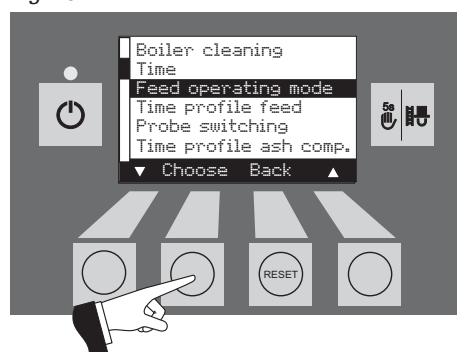

Fig. 76

¹⁾ Only displayed if a feed system is present and if this has been adjusted by a trained service technician in the service level.

Operation

The **factory setting** for „Feed operating mode“ is „switched off“.

Without time control: Select this if the feed noise (suction turbine) is not audible or intrusive in the living area (or adjacent premises). This mode guarantees the fewest possible feeds because the reserve supply container is always „run to empty“.

Functional description: The pellet feed is automatically switched on if required at any time.

With start time: Select this if you want the feed to start at the same time every day.

Functional description: The reserve supply container is filled every day if required at the set time (see page 30). Interim fills are also performed if the filling amount is not sufficient for 24 hours.

With enable time: Select this if the feed noise (suction turbine) is audible or intrusive in the living area (or adjacent premises).

Functional description: The pellet feed is enabled during a time period that can be set (see page 31) and is automatically started at this time if required. The reserve supply container is fully refilled at the end of the enable time, if required.

Tip: A complete fill sucks in about 25 kg of pellets. Even if more pellets are required during the blocked time, there is no automatic fill and the FireWIN switches off (fault message 381). Therefore, do not select a lock-out time that is too long.

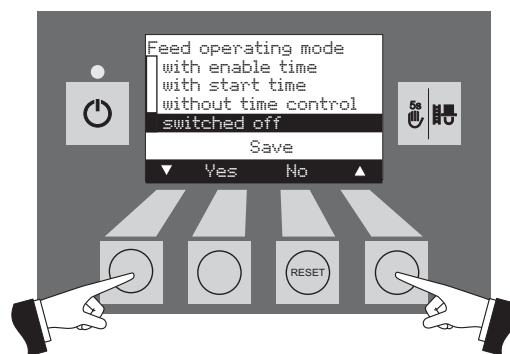

Fig. 77

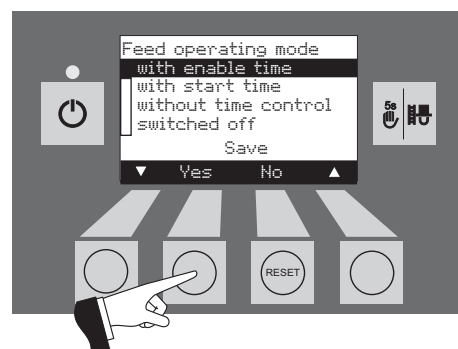

Fig. 78

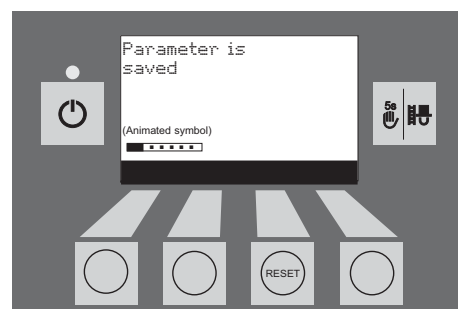

Fig. 79

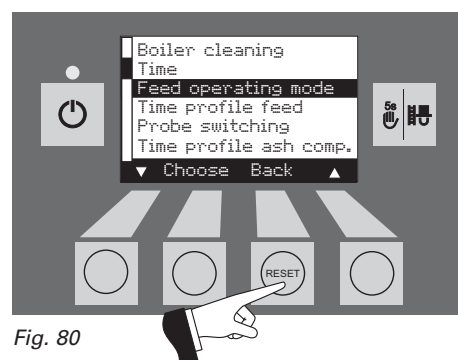

Fig. 80

Burning duration with 25 kg pellets	
FireWIN	Burning duration at nominal output
FW 090	approx. 12.5 h
FW 120	approx. 10 h



It is only ever possible to select one menu item at a time. The „Time profile feed“ corresponding to this selected menu item can then be set in section 2.8.1.3

Use the *arrow* buttons to select the required sub-menu item – Fig. 77.

Save the changed feed operating mode by pressing the *Yes* button – Fig. 78. The display shows „Parameter is saved“ for a few seconds (Fig. 79) and then changes back to the previous level – Fig. 80.

The menu item or sub-menu item is exited by pressing the *Back* button (Fig. 80) or after a delay of 45 seconds.

Operation

2.8.1.4 Time profile feed¹⁾

The „Time profile feed“ menu item displays the corresponding setting option depending on the setting in the „Feed operating mode“ menu item (see section 2.8.1.3).

Setting: „with enable time“ see page 31

Setting: „with start time“ see page 30

Setting: „without time control“ or „switched off“ see page 32

Pressing one of the six buttons switches the lighting and display on – Fig. 81.

Press the *Menu* button – Fig. 82.

Confirm the selected menu item „Operator level“ by pressing the *Choose* button – Fig. 83.

Use the *arrow* buttons to select the sub-menu item „Time profile feed“ – Fig. 84.

Confirm the selected sub-menu item „Time profile feed“ by pressing the *Choose* button – Fig. 85.

¹⁾ Only displayed if a feed system is present and if this has been adjusted by a trained service technician in the service level.

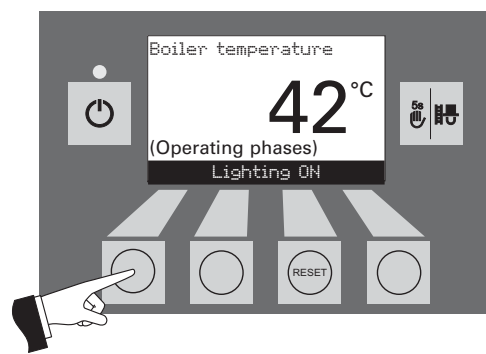

Fig. 81

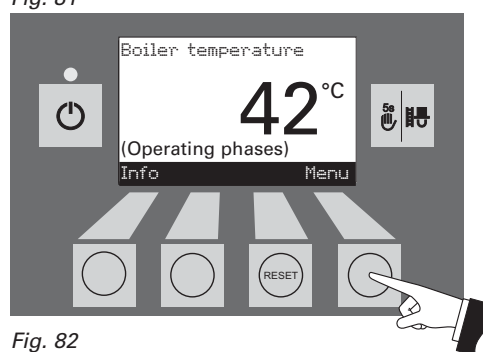

Fig. 82

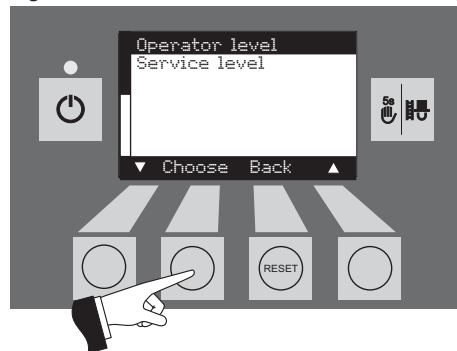

Fig. 83

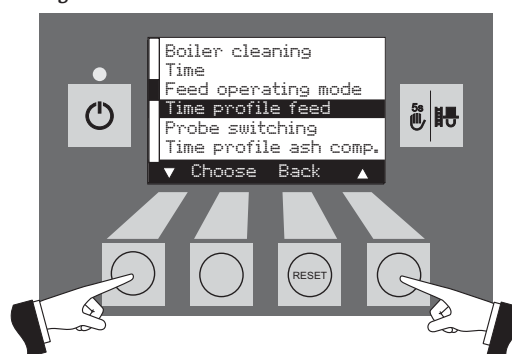

Fig. 84

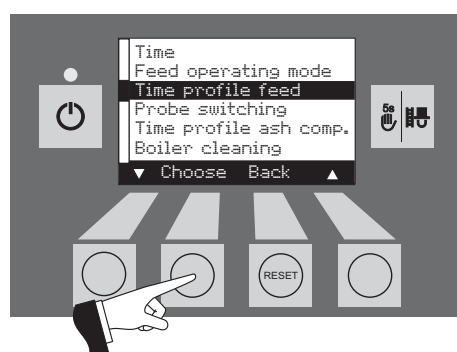

Fig. 85

Operation

„with start time“

A time can be set here in the „Time profile feed“ menu item for filling the reserve supply container if the „with start time“ setting is active in the „Feed operating mode“ menu item (see section 2.8.1.3). The reserve supply container is filled every day at the set time. Interim fills are also performed if the filling amount is not sufficient for 24 hours.

Factory setting „Feed start time“: Start 20:00

Pressing the + or – button changes the time in 1 min. steps – Fig. 86.

Save the changed time by pressing the Yes button – Fig. 87. The display shows „Parameter is saved“ for a few seconds (Fig. 88) and then changes back to the previous level – Fig. 89.

The menu item or sub-menu item is exited by pressing the *Back* button (Fig. 89) or after a delay of 45 seconds.

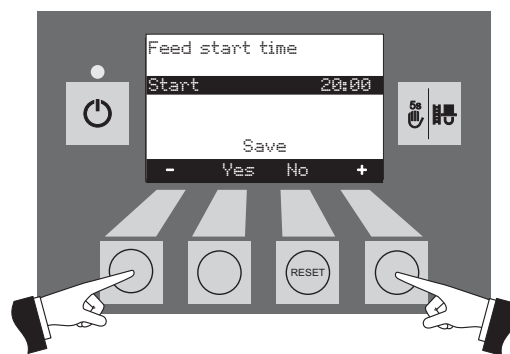

Fig. 86

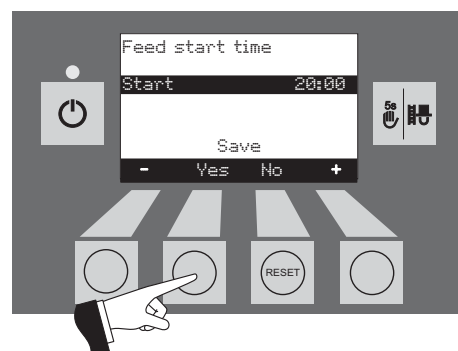

Fig. 87

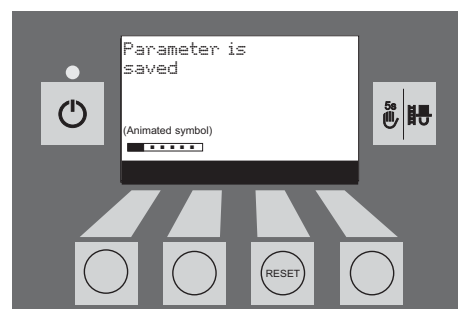

Fig. 88

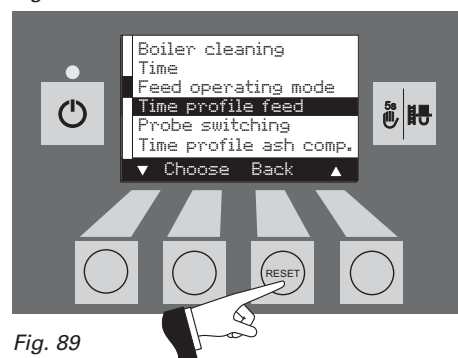

Fig. 89

Operation

The menu item or sub-menu item is exited by pressing the *Back* button (Fig. 95) or after a delay of 45 seconds.

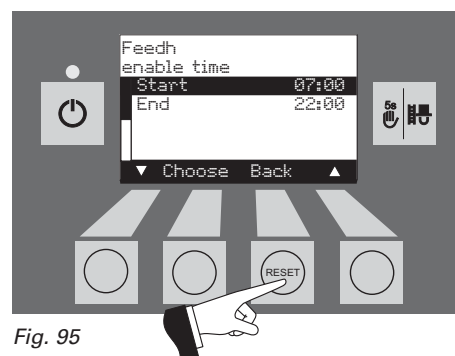

Fig. 95

The menu item or sub-menu item is exited by pressing the *Back* button (Fig. 96) or after a delay of 45 seconds.

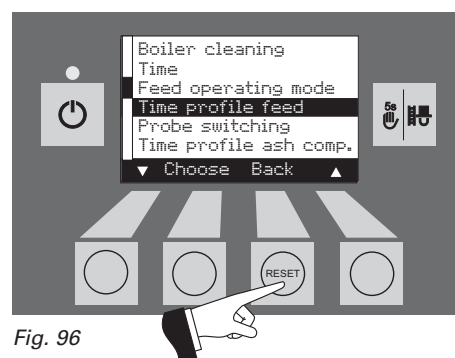

Fig. 96

„without time control“ or „switched off“

No setting is possible here in the „Time profile feed“ menu item if the „without time control“ or „switched off“ setting is active in the „Feed operating mode“ menu item (see section 2.8.1.3) – Fig. 97.

The menu item or sub-menu item is exited by pressing the *Back* button (Fig. 97) or after a delay of 45 seconds.

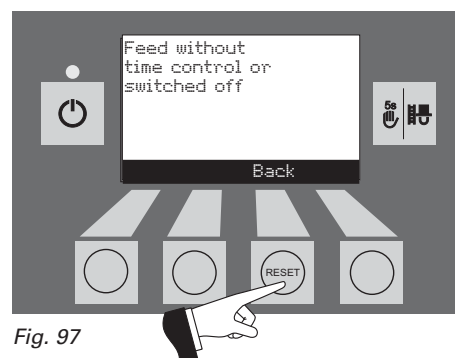

Fig. 97

Operation

2.8.1.5 Probe switching¹⁾

If FireWIN is equipped with a fully automated pellet feed, it is possible to set here which probe is used for sucking pellets from the pellet storage room. There are four different setting options:

- Automatic: Removal from all 3 probes, automatic switching.
- Only probe 1: Removal from probe 1 only, no switching
- Only probe 2: Removal from probe 2 only, no switching
- Only probe 3: Removal from probe 3 only, no switching

Note: If „Pellet feed system, operation with 2 probes“ is set in the „Service level“, the option of „Only probe 3“ is not displayed here.

Pressing one of the six buttons switches the lighting and display on – Fig. 98.

Press the *Menu* button – Fig. 99.

Confirm the selected menu item „Operator level“ by pressing the *Choose* button – Fig. 100.

Use the *arrow* buttons to select the „Probe switching“ sub-menu item – Fig. 101.

Confirm the selected sub-menu item „Probe switching“ by pressing the *Choose* button – Fig. 102.

¹⁾ Only displayed if a feed system is present and if this has been adjusted by a trained service technician in the service level.

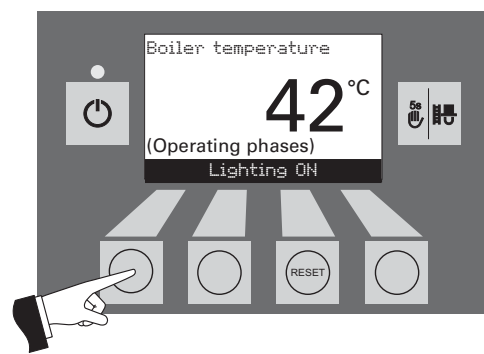

Fig. 98

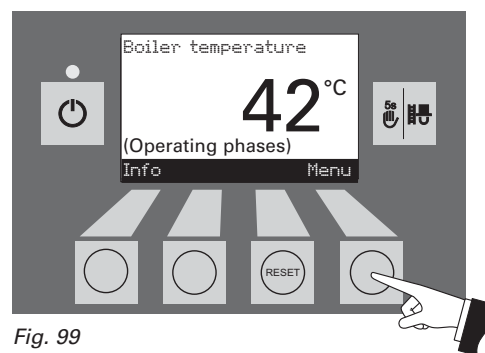

Fig. 99



Fig. 100

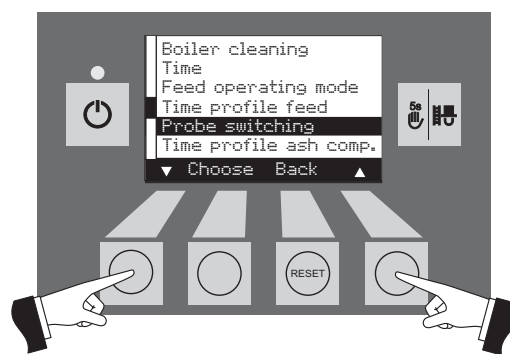

Fig. 101

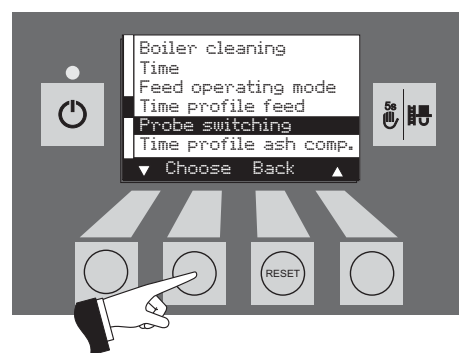

Fig. 102

Operation

Use the *arrow* buttons to select the required probe switching – Fig. 103.

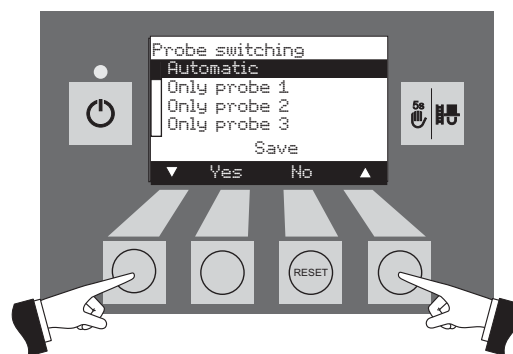

Fig. 103

Save the changed probe switching by pressing the *Yes* button – Fig. 104. The display shows „Parameter is saved“ for a few seconds (Fig. 105) and then changes back to the previous level.

Tip: This menu item is also needed for „Pellet store maintenance“ in order to activate one specific probe at a time – see also the pellet store planning documents.

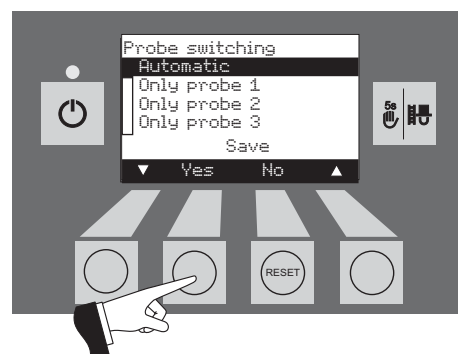

Fig. 104

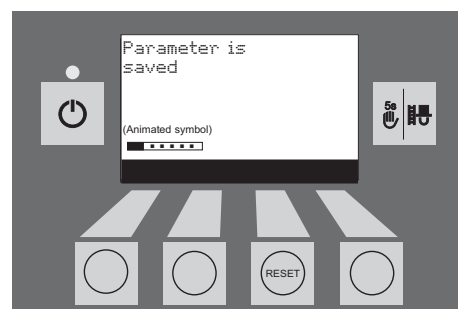

Fig. 105

The menu item or sub-menu item is exited by pressing the *Back* button (Fig. 106) or after a delay of 45 seconds.

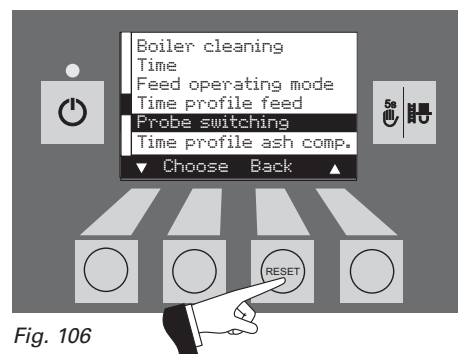

Fig. 106

Operation

Use the *arrow* buttons to select the start time you want to change, 1 or 2 – Fig. 112.

Confirm the selected start time by pressing the *Choose* button – Fig. 113.

Pressing the *+* or *-* button changes the time in 15 min. steps – Fig. 114.

Save the changed time by pressing the *Yes* button – Fig. 115. The display shows „Parameter is saved“ for a few seconds (Fig. 116) and then changes back to the previous level.

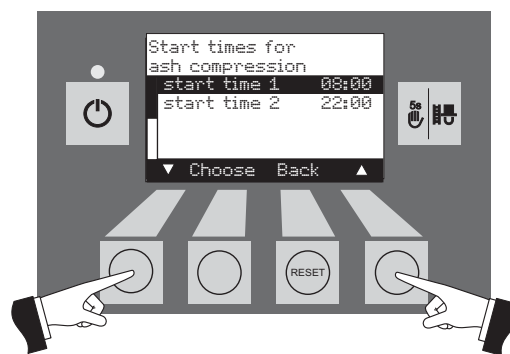

Fig. 112

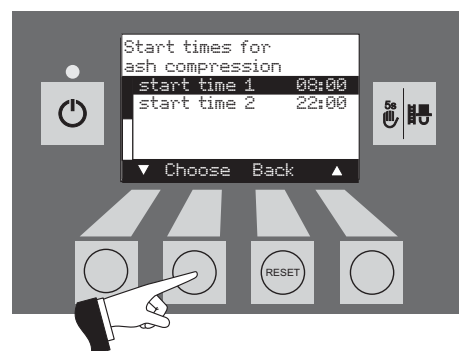

Fig. 113



Fig. 114



Fig. 115

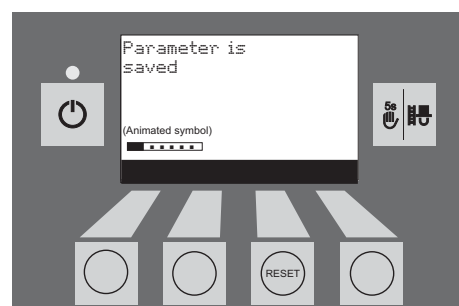

Fig. 116

Operation

2.8.2 Service level

System parameters, start-up and the actuator test can be displayed, performed and/or modified in the service level.



Changes in the Service level may be performed only by trained service personnel (directions for setting, see the FireWIN assembly instructions).

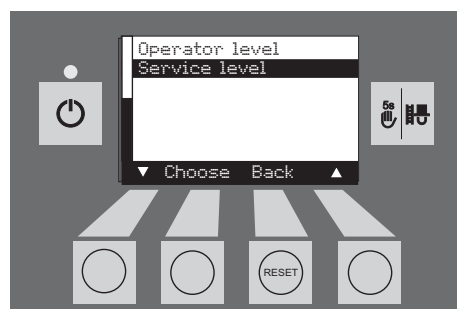

Fig. 117



Fig. 118

The menu item or sub-menu item is exited by pressing the *Back* button (Fig. 119) or after a delay of 45 seconds.

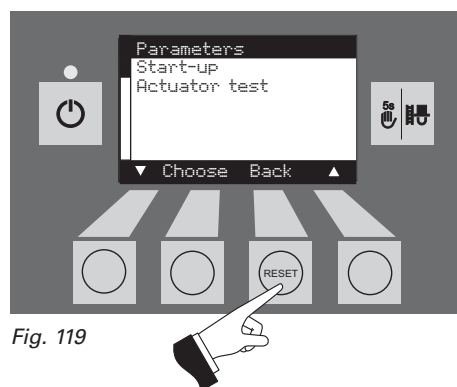



Fig. 119

Operation

2.9 Heating system operation

2.9.1 FireWIN with MES system control

Switching on – Automatic operation:

1. Press the ON/OFF button  on the InfoWIN panel, the display lighting is switched on, the signal lamp lights up green and a self-test is performed (see also section 2.5.2). After a successful self-test and if a setpoint is transferred by the system control, the FireWIN automatically starts operation.
2. Set the operating mode switch(es) on the MES control module(s) to „Automatic operation“ . The system is operated (temperatures and operating times set) using the user module (installed in the living area) – please refer to the MES and user module instructions.

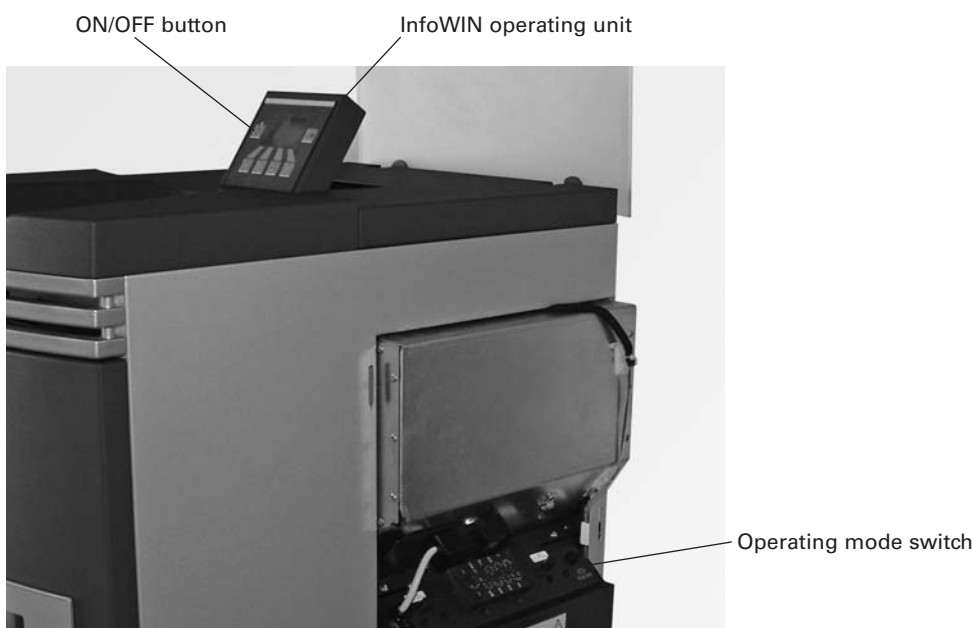



Fig. 120 FireWIN with MES system control



For operation of the MES and user module(s), please see the respective operating instructions.

Switching off:

1. Set the operating mode to „Standby“  using the user module (installed in the living area).
2. If the boiler has been out of service for an extended period during the summer months, press the ON/OFF button  on the InfoWIN unit.





The anti-freeze function is not active when the boiler is shut off.

Flue cleaning function:

This is operated using the InfoWIN unit – see section 2.5.6.



Emergency operation:

In the event that the control system fails, selecting the „Manual operation“ mode on the MES control module  and InfoWIN unit   (see section 2.5.5) will activate emergency operation to maintain heat and hot water.

Operation

2.9.2 FireWIN with REG standard control

Switching on – Automatic operation:

1. Press the ON/OFF button  on the InfoWIN panel, the display lighting is switched on, the signal lamp lights up green and a self-test is performed (see also section 2.5.2). After a successful self-test and if a setpoint is transferred by the system control, the FireWIN automatically starts operation.
2. Set both manual switches to the „Automatic“  position.
3. Set the operating mode switch on the REG standard control unit RAM 786 to „Automatic operation“ . The REG standard control unit RAM 786 (installed in the living area) is used to operate the system (set the desired temperatures and operating times) – please refer to the separate operating instructions.

The time must be set on the InfoWIN (see section 2.8.1.1). The time is used for the time control of the pellet feed, automatic heating surface cleaning and automatic ash compression.

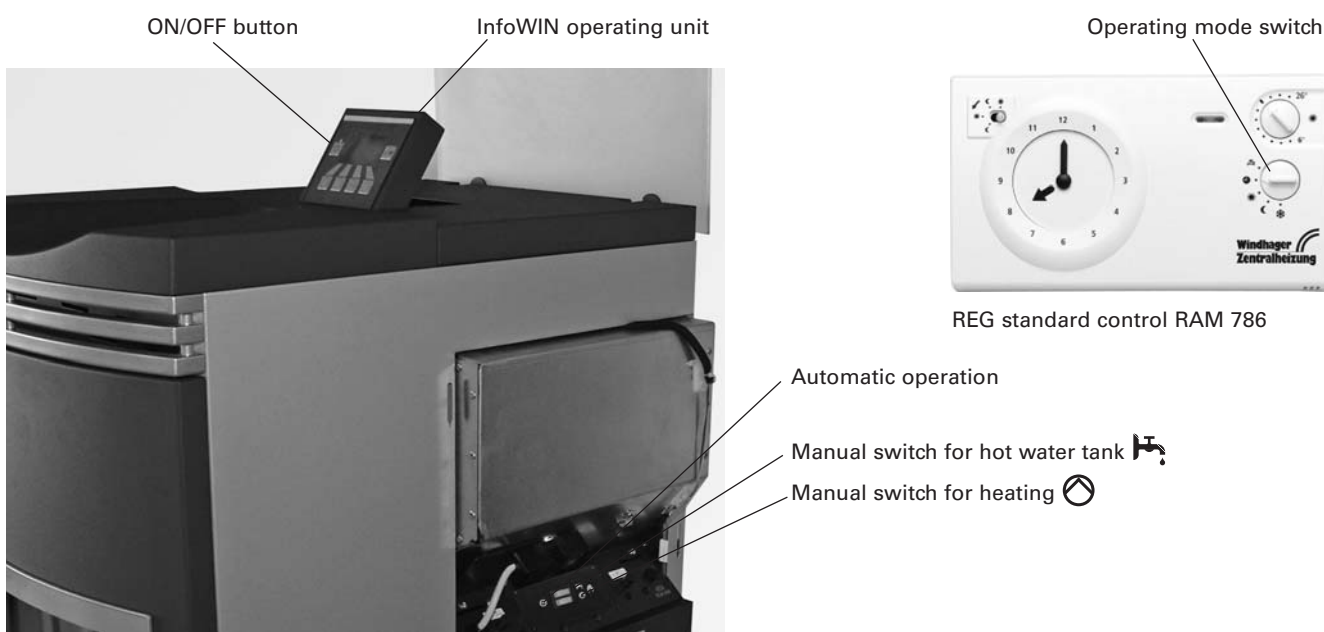



Fig. 121 BioWIN with REG standard control

Switching off:

1. Set „Standby“  operating mode on the REG standard control unit (installed in the living area).
2. If the boiler has been out of service for an extended period during the summer months, press the ON/OFF button  on the InfoWIN unit.







The anti-freeze function is not active when the boiler is shut off.

Flue cleaning function:

This is operated using the InfoWIN unit – see section 2.5.6.





Emergency operation:

If the control system fails, you can use the two manual switches  and  on the boiler control panel and the button on the InfoWIN unit   (see section 2.5.5) to activate emergency operation to maintain heat and hot water.





Operation

How to switch to emergency (manual) operation





Heating emergency operation:

1. There must be power to the boiler. The unit is switched on (otherwise, press the ON/OFF button  on the InfoWIN unit).
2. Select „Manual operation“  |  on the InfoWIN unit – see section 2.5.5.
3. Set the manual switch to the „Heating manual operation“ position .
4. Also set the motorised mixing valve to manual operation and select the desired flow temperature. The boiler temperature will be maintained at the selected temperature (60 to 75 °C). **Exercise caution if you have underfloor heating.**

Emergency operation of boiler reservoir with feed pump:

1. There must be power to the boiler. The unit is switched on (otherwise, press the ON/OFF button  on the InfoWIN unit).
2. Select „Manual operation“  |  on the InfoWIN unit – see section 2.5.5.
3. Set the manual switch to the „Hot water tank manual operation“ position .
4. Once the desired hot water temperature has been reached, set the manual switch to the „Hot water tank automatic operation“ position .

Emergency operation of hot water tank loading with charging valve:

1. There must be power to the boiler. The unit is switched on (otherwise, press the ON/OFF button  on the InfoWIN unit).
2. Select „Manual operation“  |  on the InfoWIN unit – see section 2.5.5.
3. Set both manual switches  and  to the „Manual operation“ position.

Care, cleaning and maintenance

3.1 Care of the front window, cladding and keyboard foil

The front window is equipped with a special back ventilation. This ensures that the window remains clean for a relatively long time. Nevertheless, light deposits formed by ash constituents will form on the inside of the glass window (inside window). This causes the viewing window to be obscured. This obscuring has **no effect whatsoever on the quality of combustion**. The coating can be removed with the door open using **water and a cleaning cloth when the glass is cold**. If the glass window is very dirty, moisten the cleaning cloth and dip it in the ash first, then clean.

Tip: Position newspaper or the like to protect the floor against fly ash before opening the combustion chamber door.

Also clean the cladding and the keyboard foil with a moist cloth as needed. In the event of heavy soiling, use soapy water or diluted suds (do not use strong cleaners or sharp cleaning instruments).

3.2 Cleaning and operating implements

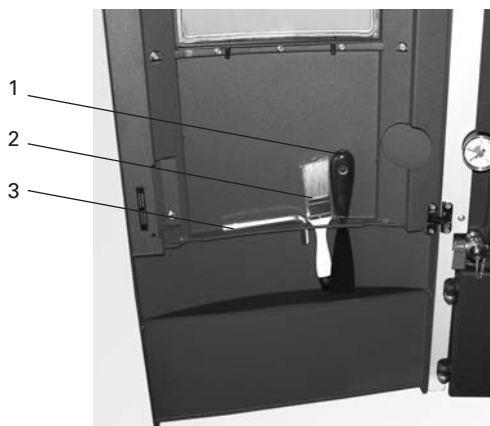

Fig. 122 Cleaning and operating implements in the cladding door

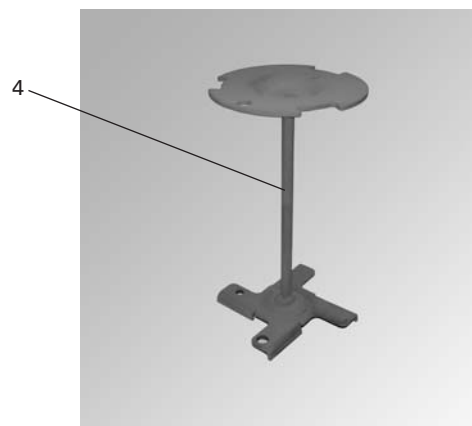

Fig. 123 Cleaning tool or removal device for cone

- 1Spatula
- 2Cleaning brush
- 3Allen key for cleaning heating surfaces
- 4Cleaning tool or removal device for cone

3.3 Overview of intervals between maintenance

A clean boiler saves fuel and protects the environment. Fly ash and combustion residues must be cleaned off the pellet central heating boiler for living areas at regular intervals. Therefore always clean your boiler as required!

Annual maintenance is required in addition to cleaning. This is performed by WINDHAGER Customer Service or the customer service PARTNERS and is a prerequisite of the guarantee limitations.

The cleaning and ash removal intervals may be reduced or extended depending on the pellets used (e.g. ash proportion), the power consumed by the heating system (frequently switching on and off) and the boiler size of the FireWIN (9 to 12 kW).

The FireWIN is equipped with a cleaning interval display. The cleaning request for the combustion chamber and burner pot is displayed on the InfoWIN and must be reset after cleaning is finished – see section 2.8.1.6.

Care, cleaning and maintenance

Maintenance intervals	FireWIN Klassik	FireWIN Premium	FireWIN Exklusiv
Depending on pellet consumption Approx. every 37 kg (~ 20 operating hours)	Add pellets to reserve supply container	–	–
Depending on pellet consumption Approx. every 400 kg (~ 250 operating hours)	Empty the ash pan(s) Operate the heating surface cleaning lever Frequent use of the lever increases efficiency	Empty the ash pan(s) Operate the heating surface cleaning lever Frequent use of the lever increases efficiency	–
Display "Clean boiler and burner" IN 580 FE 390	Clean combustion chamber and burner pot Empty the ash pan(s) Operate the heating surface cleaning lever Frequent use of the lever increases efficiency	Clean combustion chamber burner pot Empty the ash pan(s) Operate the heating surface cleaning lever Frequent use of the lever increases efficiency Check the FireWIN reserve supply container, if necessary remove dust	–
Display "Clean boiler and burner" IN 580 FE 390	–	–	Clean combustion chamber burner pot Check reserve supply container FireWIN, if necessary remove dust Empty the ash pan(s)
At least once per heating season	Clean the top heating surfaces and linkage Clean blower wheel and blower box Clean exhaust pipe to flue Check the reserve supply container, if necessary remove dust	Clean the top heating surfaces and linkage Clean blower wheel and blower box Clean exhaust pipe to flue Remove dust from reserve supply container and clean filter Check the storage room or storage container, if necessary remove dust	Clean the top heating surfaces and linkage Clean blower wheel and blower box Clean exhaust pipe to flue Remove dust from reserve supply container and clean filter Check the storage room or storage container, if necessary remove dust

Care, cleaning and maintenance

3.4 Heating surfaces

FireWIN Klassik and Premium

Optimum efficiency is achieved when the heating surfaces are cleaned as often as possible using the cleaning lever. However, the cleaning lever should be connected on the right side and moved backwards and forwards several time at the latest **before** the ash pan is removed or the ash removed from the heating surfaces — Fig. 124.



Fig. 124 Connect the lever and operate it

FireWIN Exklusiv

The heating surfaces are cleaned fully automatically after the set start times (see section 2.8.1.5) and when approx. 15 kg of fuel has been consumed ⇒ on average 1x a day.

3.5 Ash pan, ash on heating surface



Always switch the boiler off first with the ON/OFF button (Fig. 125) and wait until burnout mode has finished. Do not open the combustion chamber and ash door during operation.

Tip: Position newspaper or the like to protect the floor against fly ash before opening the combustion chamber door.

- Open the cladding door and ash door, empty the ash pan under the combustion chamber and the ash pan for the heating surfaces (accessory) or remove the ash from the duct – Fig 126.

Assembly:

- Push in the ash pan(s), close the doors.
- Switch the FireWIN back on with the ON/OFF button.



Fig. 125 Switching off FireWIN



Ash pan for heating surfaces (accessories)

Fig. 126 Empty the ash pan(s) or remove the ash from the heating surface duct



When emptying the ash pan(s), remember that there could still be embers in the ash!

Care, cleaning and maintenance

3.6 Combustion chamber

The FireWIN is equipped with a cleaning interval display. The cleaning request for the combustion chamber and burner pot is displayed on the FireWIN Klassik and Premium after 500 operating hours, on the FireWIN Exklusiv after 750 operating hours and must be reset after cleaning has finished – see section 2.8.1.6. „Boiler cleaning – Resetting the cleaning request“.



Do not open the combustion chamber door during operation. Always switch the boiler off first with the ON/OFF button (Fig. 127) and wait until burnout mode has finished. It is essential to let the boiler cool down before cleaning.

3.6.1 Baffle plate, thermocontrol sensor

- Open the combustion chamber door, lift the baffle plate at the right and guide it out at an angle, sloping down to the left – Fig. 128, Removing the baffle plate and fly ash.
- If necessary, remove fly ash from the thermocontrol sensor with a cleaning brush. The thermocontrol sensor is located at the top left of the combustion chamber behind the baffle plate – Fig. 129.

Assembly:

By working through these steps in reverse order.



Fig. 127 Switching off FireWIN



Fig. 128 Removing and cleaning the baffle plate





Thermocontrol sensor

Fig. 129 Cleaning the thermocontrol sensor (with cleaning brush)

Care, cleaning and maintenance

3.6.2 Burner pot

 Do not open the combustion chamber door during operation. Always switch the boiler off first with the ON/OFF button and wait until burnout mode has finished. It is essential to let the boiler cool down before cleaning.

 Before cleaning with a vacuum cleaner, check that there are no longer any embers in the combustion residue!

Clean the burner pot once the secondary air holes or the holes in the primary air pin are partly blocked or the unit prompts you to clean the burner pot with a fault message.

 The glow ignition is located in the primary air tube so avoid shaking the burner pot violently – risk of breakage!

- Lift out the cone (3) using the cleaning tool (1) – Fig. 130.
- Use the spatula to scrape off the deposits from all sides of the cone (3), but particularly on the underside.
- Vacuum out the burner pot, remove the primary air pin (4) and carefully clean the holes with a small screwdriver or drill bit if necessary (holes must be clear).
- Lift out and remove the grate plate (5) from below through the base of the burner pot. Scrape off ash residues from the grate plate (5) and from the hole in the middle using the spatula to clean it.
Tip: Dampen stubborn residue with water before scraping off.
- Scrape combustion residue off the burner pot base by turning the cleaning tool (1) – Fig. 130. The pipe for the primary air pin serves as a guide for the cleaning tool – see detail. Use the spatula to scrape the edges of the burner pot base clean. All secondary air holes (6) must be clear - clean them with a small screwdriver or drill bit if necessary.
- Remove combustion residue from the burner pot with a vacuum cleaner. Vacuum the ash out of the primary air tube (in the middle of the burner pot).

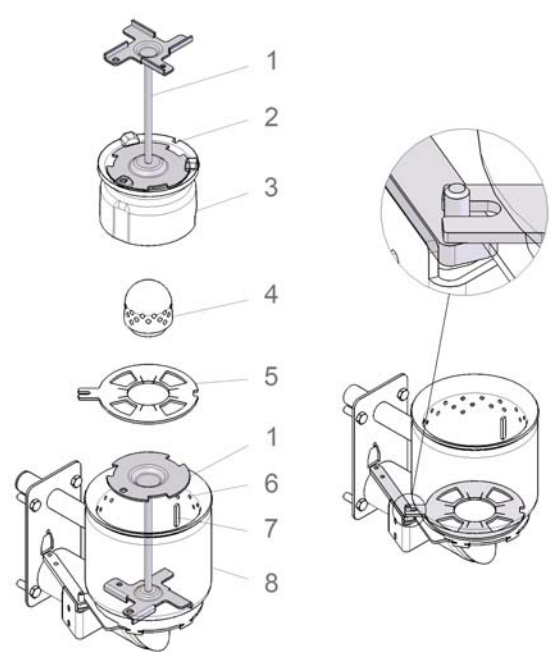
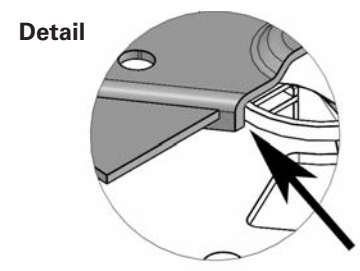

Fig. 130

Fig. 131

- 1 Cleaning tool or removal device for cone
- 2 Guide groove for locking the cone in the burner pot
- 3 Cone
- 4 Primary air pin
- 5 Grate plate
- 6 Secondary air holes
- 7 Lock for cone
- 8 Burner pot



Assembly:

- Insert the grate plate (5), making sure the projection/opening of the grate plate (5) projects through the driver of the driving rod and rests fully on the bottom grate plate – Fig. 131.
Important: Before inserting the primary air pin (4), once again vacuum out the primary air tube in the middle of the burner pot. Make sure there is no debris in the tube (to avoid damage to the ignition element!).
- Insert the primary air pin (4) (groove must engage with anti-twist device).
- Place the cone (3) into the burner pot using the cleaning tool (1). The guide groove (2) on the cone must engage with the lock (7) – Fig. 130.
- **Note:** After cleaning, the cleaning request for the combustion chamber and burner pot is reset on the Info-WIN – see Section 2.8.1.1.

Care, cleaning and maintenance

3.7 FireWIN reserve supply container

It is necessary to clean the reserve supply container if too much dust has collected on the sides or at the opening above the auger, or there are foreign bodies in the reserve supply container. In order to be able to check this, there must not be any pellets in the reserve supply container. Therefore, allow the pellets in the reserve supply container to be consumed or, in the case of FireWIN with automated feed, switch off the feed on the day before (see section 2.8.1.3 Setting the feed operating mode).

Cleaning

FireWIN **without** fully automated pellet feed:

- Switch off the FireWIN with the ON/OFF button on the InfoWIN (Fig. 132) and wait until the display has gone out.
- **Close the glass cover – danger of damage** – Fold open the cover of the reserve supply container (Fig. 133) and vacuum out the pellets, dust or foreign bodies through the mesh using a vacuum cleaner.



Fig. 132 Switching off FireWIN



Fig. 133 Folding open the cover

FireWIN **with** fully automated pellet feed:

- Switch off the FireWIN with the ON/OFF button on the InfoWIN (Fig. 134) and wait until the display has gone out.
- Remove the cover at the front– Fig. 135.



Fig. 134 Switching off FireWIN



Fig. 135 Folding open the cover

- Remove the screw on the front of the reserve supply container cover (Fig. 136), **close the glass cover – danger of damage** – and open the reserve supply container cover– Fig. 137.



Fig. 136 Switching off FireWIN



Fig. 137 Folding open the cover

Care, cleaning and maintenance

- Remove both knurled screws (Fig. 138) and fold open the inspection cover (Fig. 139).
- Remove dust (bridge formation) from the container and from both Fill level switch (proximity switch) using a vacuum cleaner.
- Close the inspection cover again and screw it on with knurled screws.

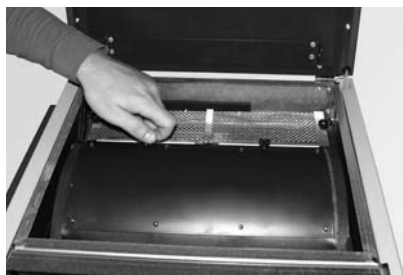

Fig. 138 Removing the knurled screws

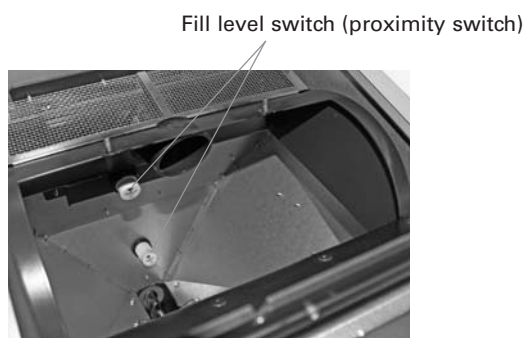

Fig. 139 Folding open the inspection cover, removing dust

- Remove both knurled screws at the back from the coarse filter (Fig. 140) and remove the coarse filter (Fig. 141).
- Remove pellets and dust using a vacuum cleaner.
- Put the coarse filter back on and screw it on with knurled screws.



Fig. 140 Removing the knurled screws

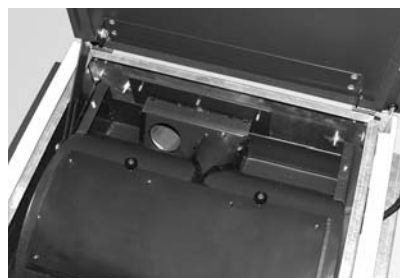

Fig. 141 Removing the coarse filter, removing pellets and dust

Assembly:

By working through these steps in reverse order.

Care, cleaning and maintenance

3.8 Top heating surfaces and linkage

These parts are automatically checked and cleaned as part of the annual maintenance by WINDHAGER Customer Service or the customer service PARTNER.

 Always switch the boiler off first with the ON/OFF button (Fig. 142) and wait until burnout mode has finished. It is essential to let the boiler cool down before cleaning.

- Remove the front cover (tip: open the cover of the reserve supply container first) – Fig. 143.



Fig. 142 Switching off FireWIN



Fig. 143 Removing the cover

- Unscrew two wing nuts from the heating surface cover and remove the complete cover – Fig. 144.
- Remove the jet protection plate (tip: vacuum out fly ash first using a vacuum cleaner) – Fig. 145.



Fig. 144 Removing the wing nuts and cover



Fig. 145 Removing the jet protection plate

- Vacuum down the top heating surfaces and linkage or clean with a cleaning brush – Fig. 146.
- Only with FireWIN Klassik and Premium: Push on the cleaning lever of the heating surfaces at the right side and move it forwards and backwards several times — Fig. 147.



Fig. 146 Cleaning top heating surfaces and linkage



Fig. 147 Connecting the lever and operating it several times

- Empty the ash pan for the heating surfaces (accessory) or remove the ash from the duct – Fig. 148.



Fig. 148 Removing the ash pan(s) or removing the ash

Care, cleaning and maintenance

3.9 Pressure measuring nipple, rotary feeder, blower wheel, blower box and exhaust pipe

These parts are automatically checked and cleaned as part of the annual maintenance by WINDHAGER Customer Service or the customer service PARTNER.



It is essential to let the boiler cool down before cleaning.

- Unhook the right side panel cladding and disconnect the mains power plug over the control panel – Fig. 149
- Remove the screw under the mains power plug on the control panel (Fig. 149) and swivel open the control panel.

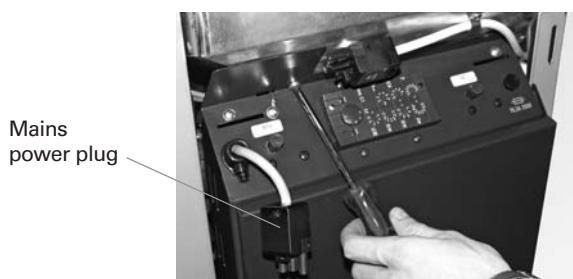

Fig. 149 Removing the power plug and screw

3.9.1 Pressure measuring nipple for combustion chamber pressure switch

The pressure measuring nipple must always be free from fly ash so that the combustion chamber pressure can be monitored.

Cleaning:

- Pull the pressure hose off the pressure measuring nipple (Fig. 150) and clean the induction opening in the pressure measuring nipple, e.g. using a small screwdriver, drill bit or the like – Fig. 151.
- Push the pressure hose back onto the measuring nipple.

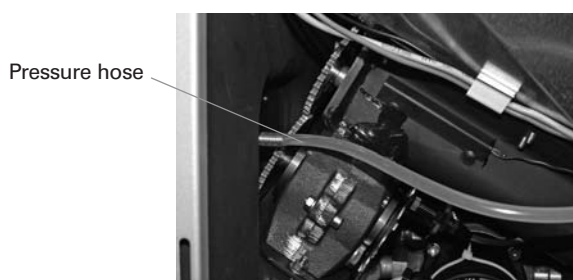

Fig. 150 Pulling off the pressure hose

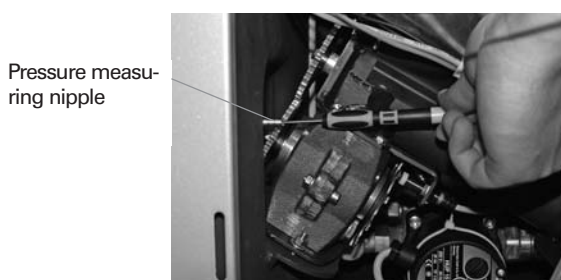

Fig. 151 Cleaning the induction opening with a small screwdriver or the like

3.9.2 Rotary feeder

Cleaning:

- Unscrew the screw plug (WAF 22) from the rotary feeder (Fig. 152) and vacuum pellet dust out of the rotary feeder using a vacuum cleaner.
- Screw the screw plug back in.

Care, cleaning and maintenance

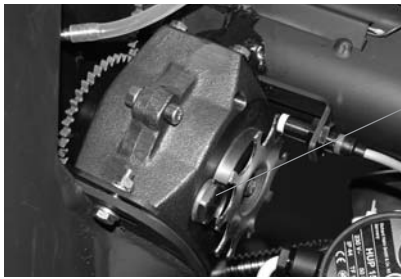

Screw plug

Fig. 152 Removing dust from the rotary feeder

3.9.3 Blower wheel, blower box and exhaust pipe to flue

- Unscrew two wing nuts from the exhaust pipe and remove the cleaning cover (Fig. 153). Clean fly ash out of the exhaust pipe with a vacuum cleaner. Close the cleaning cover again.
- Disconnect the blower plug – Fig. 154.

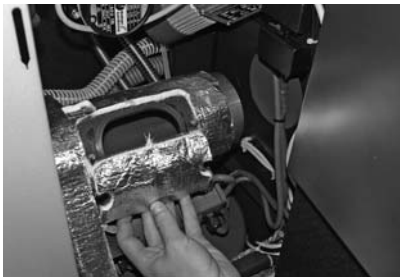

Fig. 153 Removing the wing nuts and cleaning opening – cleaning the exhaust pipe



Fig. 154 Disconnecting the blower plug

- Unscrew two wing nuts from the blower box and remove the complete blower unit – Fig. 155.
- Clean the blower wheel using a spatula and brush – Fig. 156.
- Inside of blower box: Clean fly ash with a vacuum cleaner.



Fig. 155 Removing wing nuts, removing the blower unit



Fig. 156 Cleaning the blower wheel

Assembly:

- Guide the blower unit in at the back using the stay bolts and attach at the front with two wing nuts.
- Reconnect the blower plug.
- Close the control panel, connect the securing mechanism and mains power plug at the top using a screw and hook in the side panel.

Troubleshooting

The FireWIN pellet boiler is self-monitoring during operation. All deviations from normal operation are displayed on the InfoWIN by information, fault or alarm messages. If one of these messages appears, the LED lights up red, an information, fault or alarm symbol flashes, and an information code is displayed along with a brief description in full text – Fig. 157.

Pressing the *Info* button (Fig. 157) displays the related information text (Fig. 158). To exit the information text menu, press the *Back* button (Fig. 158) or wait 10 seconds and the information, fault or alarm message is displayed again – Fig. 157.

With almost all messages, it is necessary to press the *Reset* button after rectifying the cause of the information, fault or alarm message. In these cases, „Reset“ is displayed in the menu line – Fig. 157.

If „Reset“ is not displayed in the menu line, the boiler starts operating again automatically after the cause of the information, fault or alarm message has been rectified.

Pressing the *Test* button changes to the actuator test immediately – Fig. 159. This function is only intended for trained service personnel (for setting instructions, see the FireWIN installation instructions). Pressing the *Back* button (Fig. 160) exits the actuator test.

 All safety functions are deactivated during the actuator test!

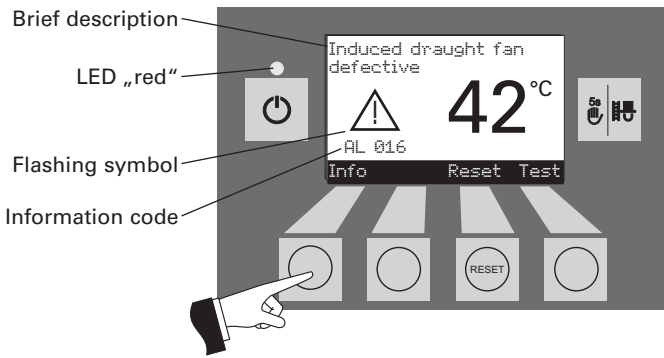

Fig. 157

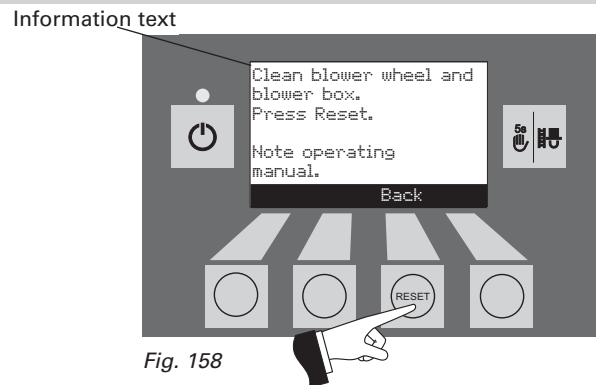

Fig. 158

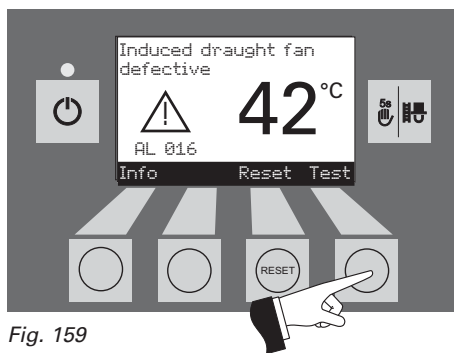

Fig. 159

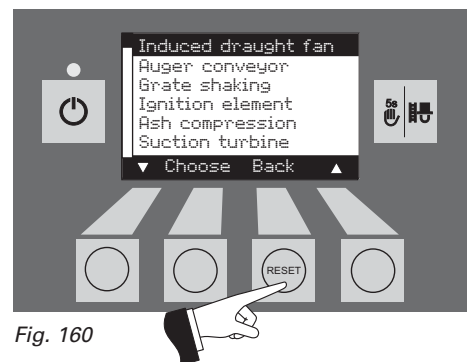

Fig. 160

If you wish to call WINDHAGER Customer Service or your customer service PARTNER due to a malfunction, please first make a note of the following data from the rating plate:

- Model
- Factory number
- Year of manufacture

The rating plate is located behind the cladding door between the combustion chamber door and the ash door – Fig. 161.

Rating plate



Fig. 161 Rating plate

Troubleshooting

4.1 No display on InfoWIN

Code	Meaning/effect	Cause/remedy
-	<p>No display</p> <p>Boiler is off, cannot be switched on with the ON/OFF button.</p>	<p>a) No electricity, check the cable to the device and the building fuse.</p> <p>b) No electricity, device fuse defective – check and replace if necessary – see page 55, Fig. 163.</p> <p>c) InfoWIN plug loose or poorly connected together if connected at all during installation – check and connect together firmly if necessary, plug is located on the side at the top behind the right side panel cladding – see installation instructions; Installing the cladding.</p>

4.2 Information messages

Code	Meaning/effect	Cause/remedy
IN 581	<p>Replenish fuel</p> <p>The reserve supply container is almost empty. Top up pellets.</p>	<p>Boiler continues to heat until the remaining fuel quantity has been consumed.</p> <p>a) FireWIN Klassik (without feed): Fill fuel into the fuel container (see section 2.3).</p> <p>b) FireWIN Premium/Exklusiv (with feed): Feed is switched off in „feed operating mode“ (see section 2.8.1.2). In „Feed operating mode“ menu item, set to „with enable time“, „with start time“ or „without time control!“</p>
IN 582	<p>Reserve supply container empty</p> <p>The reserve supply container is empty. Top up pellets. Burner is locked.</p>	<p>The reserve supply container is empty.</p> <p>a) FireWIN Klassik without feed: Fill fuel into the fuel container (see section 2.3).</p> <p>b) FireWIN Premium/Exklusiv (with feed): Feed is switched off in „feed operating mode“ (see section 2.8.1.3). In „Feed operating mode“ menu item, set to „with enable time“, „with start time“ or „without time control!“</p>
IN 590	<p>Clean boiler and burner</p> <p>Perform cleaning and confirm in operator level.</p>	<p>Boiler and burner are still operating.</p> <p>Boiler and burner must be cleaned or the <u>both</u> ash pan(s) (see Fig. 162) emptied (see sections 3.4, 3.5 and 3.6). Following cleaning, confirm cleaning on the InfoWIN operator level (see section 2.8.1.1).</p>
IN 595	<p>Door open</p> <p>Burner locked. Only open the door when the burner is switched off.</p>	<p>Cladding door is open, burner locked.</p> <p>a) Close the cladding door.</p> <p>b) Door switch on cladding door does not switch correctly, adjust – see installation instructions.</p>

Troubleshooting

4.3 Fault messages

Code	Meaning/effect	Cause/remedy
FE 206	<p>Monitoring of the auger conveyor is defective</p> <p>The boiler is in operation.</p>	<p>Press the Reset button. If the fault reoccurs after a reset, inform Windhager Customer Service or a heating technician.</p>
FE 238	<p>Feed is not sucking any pellets in</p> <p>Check pellet supply in storage room and feed hose. Press Reset.</p>	<p>No pellet feed is possible. The boiler does not operate.</p> <p>a) No pellets at the suction probe – Set „probe switching“ to „automatic“ or select another probe (see section 2.8.1.5). Press the Reset button.</p> <p>b) Feed hose blocked at the intake or entry to the changeover unit – clear it. Press the Reset button.</p> <p>c) Inform Windhager Customer Service or a heating technician.</p> <p>Emergency operation: Switch off the feed unit (see section 2.8.1.3). Fill the reserve supply container with pellets by hand, boiler may continue operating without feed.</p>
FE 239	<p>Probe switching defective</p> <p>Check the changeover unit. Press Reset.</p>	<p>No pellet feed is possible. The boiler does not operate.</p> <p>Press the Reset button. If the fault reoccurs after a reset, inform Windhager Customer Service or a heating technician.</p> <p>Emergency operation: Switch off the feed unit (see section 2.8.1.3). Fill the reserve supply container with pellets by hand, boiler may continue operating without feed.</p>
FE 356	<p>Combustion chamber pressure not stable</p> <p>The boiler is in operation.</p>	<p>a) Heating surface cover leaking, check whether this is firmly closed (see section 3.8), press the Reset button.</p> <p>b) Combustion chamber and ash door are leaking – check the seal, replace the seal if necessary, press the reset button.</p> <p>c) Pressure measuring nipple of combustion chamber pressure switch is blocked – clear it (see section 3.9.1), press the reset button.</p> <p>d) Intake air line or induction opening at rear is blocked – clear it and press the reset button.</p> <p>e) Exhaust pipe or flue is blocked, clear it and press the reset button.</p> <p>f) Combustion chamber pressure switch is defective, inform Windhager Customer Service or a heating technician.</p>
FE 381	<p>Reserve supply container empty</p> <p>Time programme blocking feed. Change enable time in menu/operator level.</p>	<p>Enable time for the feed has been set too short, which means the pellets in the reserve supply container are used up and the feed is blocked.</p> <p>Extend the enable time for the feed in the „Feed operating mode“ menu item (see section 2.8.1.4) or operate „with start time“ or „without time control“ (see section 2.8.1.3).</p>

Troubleshooting

Code	Meaning/effect	Cause/remedy
FE 382	<p>Fill level switch in reserve supply container defective</p> <p>Check the switch in the reserve supply container. Press Reset.</p>	<p>The boiler does not operate.</p> <p>a) Fill level switch (proximity switch) dirty, remove the dust (see section 3.7), press the Reset button.</p> <p>b) Fill level switch (proximity switch) in the reserve supply container defective – inform Windhager Customer Service or a heating technician.</p> <p>Emergency operation: Switch off the feed unit (see section 2.8.1.3). Fill the reserve supply container with pellets by hand, boiler may continue operating without feed.</p>
FE 390	<p>Emergency operation! Clean boiler and burner</p> <p>Perform cleaning and confirm in operator level.</p>	<p>The boiler is in cyclic operation, i.e. has idle times.</p> <p>a) Boiler and burner must be cleaned or the <u>both</u> ash pan(s) (see Fig. 162) emptied (see sections 3.4, 3.5 and 3.6). Following cleaning, confirm cleaning on the InfoWIN operator level (see section 2.8.1.1).</p> <p>b) Motor or limit switch of ash compactor defective, inform Windhager Customer Service or a heating technician.</p>

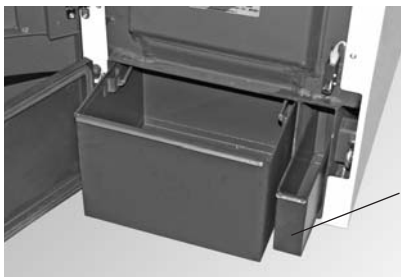



Fig. 162 Empty the ash pan(s) or remove the ash from the heating surface duct

4.4 Alarm messages

Code	Meaning/effect	Cause/remedy
AL 005	<p>Shake-out defective</p> <p>Shake-out defective or sticking. Clean the burner pot. Press Reset.</p>	<p>Shake-out motor no longer moves or no longer reaches the end position, boiler switches to burnout mode.</p> <p>a) Burner contamination; close combustion chamber doors, press reset button; once the alarm message is rectified, clean the burner pot as described in section 3.6.</p> <div style="border: 1px solid black; padding: 5px; margin: 10px 0;">  <p>The glow ignition is located in the primary air tube so avoid shaking the burner pot violently – risk of breakage!</p> </div> <p>If the alarm message remains active, clean the burner pot as described in section 3.6. Note: Grate plate at top can only be raised and removed when closed. If the grate plate is not fully closed, vacuum it out. Close combustion chamber door, press reset button, if the alarm message remains in place, repeat the process or inform Windhager Customer Service or a heating technician.</p> <p>b) Grate plate not inserted correctly or check correct installation position (see section 3.6).</p> <p>c) Motor for shake-out defective, inform Windhager Customer Service or a heating technician.</p> <p>d) Limit switch defective, inform Windhager Customer Service or a heating technician.</p>

Troubleshooting

Code	Meaning/effect	Cause/remedy
AL 006	<p>Auger conveyor motor defective</p> <p>Auger conveyor motor defective. Press Reset.</p>	<p>Boiler enters burnout mode, vacuum fan is stopped immediately.</p> <p>a) Auger conveyor or rotary feeder jammed due to a foreign body, clean the reserve supply container, opening above auger conveyor or rotary feeder (see section 3.9) and remove the foreign body. Press the Reset button. The alarm message AL 171 may light on up to 2 occasions until the boiler starts operating again, press the Reset button.</p> <p>b) Control thermostat defective, inform Windhager Customer Service or a heating technician.</p> <p>c) Press the Reset button. If the malfunction recurs immediately after a short period, or recurs at regular intervals, contact Windhager Customer Service or your heating technician.</p> <p>d) Renew the auger conveyor motor, inform Windhager Customer Service or a heating technician.</p>
AL 016	<p>Vacuum fan defective</p> <p>Clean blower wheel and blower box. Press Reset.</p>	<p>The actual speed is different from the nominal speed. The boiler switches to burnout mode.</p> <p>a) The blower wheel and blower box are dirty, press the Reset button. If the malfunction recurs immediately after a short period, or recurs at regular intervals, contact Windhager Customer Service or your heating technician.</p> <p>b) Replace the vacuum fan motor, inform Windhager Customer Service or a heating technician.</p>
AL 062	<p>Air intake/exhaust flap defective</p> <p>Air intake/exhaust flap defective or not opening. Check flap. Press Reset.</p>	<p>External air choke (optional) does not open.</p> <p>a) Check the air choke, press the Reset button.</p> <p>b) Inform Windhager Customer Service or a heating technician.</p>
AL 071	<p>Safety / emergency switch open</p> <p>Check switch position of safety / emergency switches.</p>	<p>Boiler enters burnout mode but the blower does not run.</p> <p>Switch on emergency heating/OFF switch.</p>
AL 076	<p>Boiler sensor defective</p> <p>Check the boiler sensor and connections. Press Reset.</p>	<p>The boiler switches to burnout mode.</p> <p>a) Press the Reset button. If the malfunction recurs immediately after a short period, or recurs at regular intervals, contact Windhager Customer Service or your heating technician.</p> <p>b) Replace the boiler sensor, inform Windhager Customer Service or a heating technician.</p>
AL 078	<p>Thermocontrol sensor defective</p> <p>Check the thermocontrol sensor and connections. Press Reset.</p>	<p>The boiler switches to burnout mode.</p> <p>a) Thermocontrol sensor is too cold < 0 °C. Sensor warm up.</p> <p>b) Press the Reset button. If the malfunction recurs immediately after a short period, or recurs at regular intervals, contact Windhager Customer Service or your heating technician.</p> <p>c) Replace the thermocontrol sensor, inform Windhager Customer Service or a heating technician.</p>

Troubleshooting

Code	Meaning/effect	Cause/remedy
AL128	<p>No flame formation in control mode</p> <p>Clean boiler and burner. Press Reset.</p>	<p>The flame goes out in modulation mode. The boiler switches to burnout mode.</p> <p>a) Clean the burner and the boiler. Check the exhaust pipe to the flue and clean it if necessary, press the Reset button.</p> <p>b) Auger conveyor or rotary feeder jammed due to a foreign body. Clean the reserve supply container, opening above auger conveyor or rotary feeder (see section 3.7) and remove the foreign body. Press the Reset button. The alarm message AL 171 may light on up to 2 occasions until the boiler starts operating again, press the Reset button.</p> <p>c) Inform Windhager Customer Service or a heating technician.</p>
AL 133	<p>Safety temperature shut-down</p> <p>Check the system and filling pressure. Press Release button on boiler.</p>	<p>Boiler temperature is above 100 °C, boiler enters burnout mode, vacuum fan is switched off immediately.</p> <p>a) Check the water level or pressure in the heating system – refill, bleed the air.</p> <p>b) Air in the heating system – bleed air.</p> <p>c) The heat pump or boiler feed pump is sticking or is defective – start pump manually or have it repaired.</p> <p>Once the boiler water temperature falls below 90 °C, remove the cover, press the Release button of the safety thermostat B7 firmly – Fig. 163.</p> <p>If the malfunction occurs after a short period, or recurs at regular intervals, contact Windhager Customer Service or your heating technician.</p>
AL 135	<p>Excess temperature in the auger tube</p> <p>Check the burner. Press Release button B7a on control panel.</p>	<p>The boiler switches to burnout mode.</p> <p>a) Check the burner, remove all pellets from the burner pot.</p> <p>b) Remove the cover from the safety thermostat auger tube B7a, press the Release button firmly (see Fig. 163). If the ignition does not function first time (AL 171), press the Reset button (pellets in the auger conveyor will have been damaged due to the higher temperature).</p>



Fig. 163 FireWIN control panel, rear right side panel removed

Troubleshooting

Code	Meaning/effect	Cause/remedy
AL 156	<p>No negative pressure in the combustion chamber</p> <p>No negativ pressure in combustion chamber or sensor defective. Press Reset.</p>	<p>The boiler switches to burnout mode.</p> <p>a) Heating surface cover leaking, check whether this is firmly closed (see section 3.8), press the Reset button.</p> <p>b) Combustion chamber and ash door are leaking – check the seal, replace the seal if necessary, press the reset button.</p> <p>c) Pressure measuring nipple of combustion chamber pressure switch is blocked – clear it (see section 3.9.1), press the reset button.</p> <p>d) Intake air line or induction opening at rear is blocked – clear it and press the reset button.</p> <p>e) Exhaust pipe or flue is blocked, clear it and press the reset button.</p> <p>f) Combustion chamber pressure switch is defective, inform Windhager Customer Service or a heating technician.</p>
AL 171	<p>Maximum heating up time exceeded</p> <p>Clean the burner pot. Press Reset.</p>	<p>a) FireWIN Klassik without feed: The reserve supply container is empty. Fill fuel into the fuel container (see section 2.3). Press the Reset button until the boiler starts operating again. The alarm message AL 171 may light on up to 2 occasions, press the Reset button.</p> <p>b) Clean the burner pot (see section 3.6), empty the ash pan in Klassik/Premium, press the reset button.</p> <p>c) Too much dust in the reserve supply container – bridge formation, remove the dust (see section 3.7), press the Reset button.</p> <p>d) Auger conveyor or rotary feeder jammed due to a foreign body, clean the reserve supply container or rotary feeder (see section 3.7) and remove the foreign body, refill the reserve supply container. The alarm message AL 171 may light on up to 2 occasions until the boiler starts operating again, press the Reset button.</p> <p>e) FireWIN Premium/Exklusiv with feed: Pellets stuck in the hose before the entry to the reserve supply container – move the hoses at the connection pieces, press the Reset button.</p> <p>f) Ignition defective, inform Windhager Customer Service or a heating technician.</p>
AL 187	<p>No communication with main PCB</p> <p>Check connection for main PCB and connections. Press Reset.</p>	<p>The boiler switches to burnout mode.</p> <p>a) Check the connection cable or InfoWIN plug connection to the main PCB, inform Windhager Customer Service or a heating technician.</p> <p>b) Connect the main PCB, inform Windhager Customer Service or a heating technician.</p>
AL 188	<p>Internal error occurred</p> <p>ErrorCode 188</p> <p>Current TableID 4</p>	<p>Internal communication error. The boiler switches to burnout mode.</p> <p>A reset is performed automatically after 1 minute if this error occurs.</p> <p>If the malfunction occurs after a short period, or recurs at regular intervals, contact Windhager Customer Service or your heating technician.</p>

Declaration of conformity

for the FireWIN pellet boiler series for living areas

Issued by: WINDHAGER ZENTRALHEIZUNG Technik GmbH
Anton-Windhager-Strasse 20
A-5201 Seekirchen

Subject of the declaration: FireWIN pellet boiler series for living areas

The appliances comply with the requirements in the following documents:

Document no.	Title	Standard	Edition
98/37 EC	Machinery Directive	EN 303-5	1999
73/23 EEC	Low-Voltage Directive	EN 60335-1	2001
89/336 EEC	EMC Directive	EN 61000-6-1	2001
		EN 61000-6-3	2001

Seekirchen, 25 April 2006

WINDHAGER ZENTRALHEIZUNG
Technik GmbH



Johann Thalmaier, Board of Directors

Please complete the boxes below

Serial Number

Date of Installation

D	D	M	M	Y	Y

Installer Details (name, address and contact number(s))

All descriptions and illustrations provided in this leaflet have been carefully prepared but we reserve the right to make changes and improvements in our products which may affect the accuracy of the information contained in this leaflet. All goods are sold subject to our standard Conditions of Sale which are available on request.

BAXI
A Trading Division of Baxi Heating UK Ltd (3879156)
Brooks House, Coventry Road, Warwick. CV34 4LL
After Sales Service & Technical Enquiries 0844 871 1568
Website www.baxi.co.uk
e&oe

PART OF BDR THERMEA

Guarantee & Warranty Limitations

The guarantee and warranty limitations require that the boiler and related accessories be properly installed, commissioned and started up by either i) heateam service engineer or ii) a HETAS approved engineer and the HETAS approved number must be logged on the supplied warranty card; otherwise the manufacturer's guarantee will not be honoured.

Malfunctions resulting from improper operation or adjustment as well as use of poor or not recommended fuel types are not covered by the guarantee and warranty. Further, the warranty shall be void if equipment other than those provided by heateam are installed. The special warranty restrictions for your system are available in the "Warranty Conditions" folder supplied with your boiler.

Start-up and regular maintenance following the terms of the "Warranty Conditions" will assure safe, environmentally friendly and economical operation of your system. We recommend that you obtain a maintenance service contract.

The Baxi Bioflo wood pellet sealed central heating system boiler includes a one year parts and labour guarantee. The labour guarantee is subject to a set up and test being completed by a Baxi Engineer or Baxi approved installer (HETAS Qualified).

Baxi offer a free set up and test with this product. Please contact Baxi on 0844 871 1568 to arrange this service.

Open Monday - Friday, 8am - 6pm
Saturdays, 8.30am - 2pm
We are closed on Christmas Day & New Year's Day

Alternatively your HETAS qualified installer must complete the enclosed set up and test checklist and warranty registration card and return to the address below

Warranty Registrations
Baxi Heating UK Ltd
Brooks House
Coventry Road
Warwick
CV34 4LL