

# BAXI

## Operation Installation & Maintenance Instructions



### Baxi Geoflo

Single Compressor Compact Heat Pump

Please keep these instructions in a safe place.  
If you move house, please hand them over to the next occupier

## CONTENTS

Section	Page
Compact Heat Pump Safety Information	3
Warranty Statement	4
Technical Data	5
Setting the Compact Heat Pump to work	6
Operating Instructions & Troubleshooting	7
Elevation of typical installation	8
Installation clearances	9
Hood removal clearances	10
Typical underfloor schematics	11
Ground plumbing illustration	12
Slinky® manifold connections	13
Plumbing connections	14
Output pump bleed port	15
Purge pumps	16
Purging the ground arrays	17
Typical Underfloor Wiring Connections	18
Control box layout	19
Wiring connections	20
Installation instructions	21
Installation instructions	22

© Baxi Heating UK Ltd 2006 All rights reserved. No part of this publication may be reproduced or transmitted in any form or by any means, or stored in any retrieval system of any nature (including in any database), in each case whether electronic, mechanical, recording or otherwise, without the prior written permission of the copyright owner, except for permitted fair dealing under Copyrights, Designs and Patents Act 1988.

Applications for the copyright owner's permission to reproduce or make other use of any part of this publication should be made, giving details of the proposed use, to the following address:

The Company Secretary, Baxi Heating UK Ltd, Pentagon House,  
Sir Frank Whittle Road, Derby, DE21 4XA.

Full acknowledgement of author and source must be given.

**WARNING:** Any person who does any unauthorised act in relation to a copyright work may be liable to criminal prosecution and civil claims for damages.

**Note:** The door and hood must NOT be removed by the user

### Installation

The appliance must be located well away from occupied spaces to prevent the transmission of unwanted noise and vibration. Locate the appliance in a separate room such as a utility room or garage.

Take suitable precautions to prevent damage to the appliance from frost.

Position the appliance on a firm, level and substantial concrete base that will absorb vibration and that is not adjacent to any occupied rooms.

Ensure all pipes and wires are adequately supported where necessary, pipes are properly insulated and concentrations of inhibitor are correct.

Do not place anything on the appliance.

### Prior to use

Any electrical work required to install or maintain this appliance should be carried out by a suitably qualified electrician in accordance with current IEE regulations.

Any plumbing work should be carried out to local water authority and WRC regulations.

The appliance should be left for 12 hours after installation before it is turned on, in order to allow the refrigerant to settle.

The area must be dry.

This appliance is heavy. Care should be taken when moving it.

Check the appliance for transport damage. Under no circumstances should a damaged appliance be operated or installed.

It is dangerous to modify this appliance in any way.

Ensure that the appliance does not stand on the electrical supply cable. If the supply cable is damaged, it must be replaced.

Ensure that the appliance and any metal pipes are properly earthed.

A water treatment device should be provided in hard water areas.

### Child Safety

Do not allow children to tamper with the controls or play with the appliance.

Keep any packaging material away from children to prevent danger of suffocation.

Ensure that animals are kept well away from the appliance.

### Maintenance and cleaning

Before cleaning or performing maintenance, always switch off the appliance at the electrical isolator.

Use only soap and a damp cloth; do not use solvents.

### Operation

Always ensure that all individuals using the appliance have read and fully understood the Operation instructions.

Do not operate the appliance with the cover removed or door open.

Do not operate the appliance in anything other than very dry conditions of installation.

Do not exert any strain on electrical or pipe connections to the appliance.

Do not put any foreign object into the appliance.

Do not spill water or any other substance onto the appliance.

## Baxi Geoflo Ground Source Heat Pumps

Thank you for purchasing a Baxi Geoflo Ground Source Heat Pump. This quality product has been developed to a high standard of specification and should provide you with trouble free operation for many years to come. We are very confident you have made the right choice of product and support it with a comprehensive free warranty.

### Standard Warranty Terms and Conditions

Ground source heat pump - two years  
Manifold - two years

To receive your free warranty please complete the form supplied within 30 days of installation with the Geoflo system.

#### Our promise to you.

If you experience a fault with your new Geoflo system, we aim to provide a safe and high quality repair service supported by our dedicated national network of highly skilled engineers. Together with your installer if you cannot resolve the problem, we will do everything we can to get an engineer out to you as quickly as possible. Nothing in this warranty will affect your statutory consumer rights.

#### What you need to do if you experience a problem with your Geoflo system.

You should always contact your installer first because the fault may not be related to the Geoflo system. If your installer confirms that the fault is within the Geoflo system itself and he/she decides they can't repair it our friendly customer service team is on hand to help.

Simply call our service division Heateam on **08700 603261** to book an engineer visit or for any general advice that you may need. Our contact centre is open Monday to Friday 8am - 6pm, Saturday 8.30am – 2pm closed Sundays and Bank Holidays.

Before calling Heateam please have the following information to hand: -

Geoflo system serial number  
Geoflo system model number  
Your installer name, address details and contact details  
Proof of purchase (if you do not have the Geoflo serial number)

#### What this warranty covers.

- Free of charge repair or replacement of components found to be faulty from manufacture.
- Free of charge replacement of the complete assemblies (excluding the ground array) provided always that the failure is related to a manufacturing fault that cannot be repaired or is beyond repair.
- The ground array (slinky) before backfilling trenches (a suitable pressure test must be carried out)
- Warranty runs from the date your product is installed.

#### What this warranty does not cover.

- Geoflo systems that are installed damaged or damaged during installation simply return it to the supplier for replacement under warranty.
- The warranty will become invalid if the failure is due to frost, landslip, heave, subsidence, transient voltages, lightning strikes, rodent damage or any act of vandalism, misuse or malicious conduct.
- Tampering or modification will invalidate this warranty.
- The installation must be in an appropriate location as detailed in the installation instructions.
- Repairs to Geoflo system which have not been installed or commissioned properly and as set out in the installation instructions.
- Any other defects or failures, either in the connected system or outside of the Geoflo system itself.
- Faults caused by an inadequate supply of electricity to the property.
- Reimbursement of any third party repair or replacement costs that we haven't been told about or agreed with you in advance.
- Compensation for consequential losses (e.g. loss of earnings, business losses, stress and inconvenience) arising from a product breakdown, including repair delays caused by factors outside our reasonable control.

**Baxi Geoflo Single Compressor Compact Heat Pump Technical Details  
(For Use With Underfloor Heating Systems)**

Thermal Output	kW	4	6	8	10
Power Supply		Single Phase - 230 Volts AC 50 Hz			
Building Size	m <sup>2</sup>	80	120	160	200
Slinky Length	metres	40	30	40	50
Number of Slinkies	Qty	1	2	2	3
Power supply rating	Amps	16	25	25	25
Maxi running current	Amps	11	14	19	24
Typical running current	Amps	4	6	8	10
Typical starting current	Amps	30	50	65	85
Power supply size	mm	2.5	2.5	2.5	2.5
Power Input	kW	1	1.5	2	2.5
Nominal dry weight	kg	85	90	95	100
Compressors	No. of	Single	Single	Single	Single
Dimensions	HxWxD	900 x 550 x 570	900 x 550 x 570	900 x 550 x 570	900 x 550 x 570
Connection Size (OD)	mm	28	28	28	28
Typical COP @ 0° C & 35° C	Ratio	4	4	4	4

**NOTE:**

Power supplied must be terminated in a D type MCB at the distribution board. The fuse should be sized according to the power supply rating in the above table.

## Setting the Compact Heat Pump to work

**Note:** This operation must be performed by a competent installer.

### Prior to use : -

1. Turn off the power supply at the local isolator.
2. Open the door, using a screwdriver.
3. Check that the ground pressure gauge reads at least 0.3 bar. If the pressure is lower than this, open the mains cold water supply valve (fitted outside the case) fully until the gauge reads at least 1.8 bar, at which point a "click" will be heard. Close the mains cold water supply valve fully.
4. Check that the underfloor pressure gauge reads at least 0.3 bar. If the pressure is lower than this, locate the mains cold water supply valve, and open fully until the gauge reads at least 1.8 bar, at which point a "click" will be heard. Close the mains cold water supply valve fully.
5. Close and re-lock the door.
6. Turn on the power supply at the local isolator and program the external timeclock / thermostat to use as much off-peak electricity as possible.
7. Note: There is a delay of approximately 3 minutes before the Compacts refrigeration compressor starts.
8. If you have any problems refer to the 'Troubleshooting' section

### Maintenance Instructions

No routine maintenance is required to Compact Heat Pumps, and there are no user-serviceable components inside. If further help is required then telephone our helpline on 08700 603 261

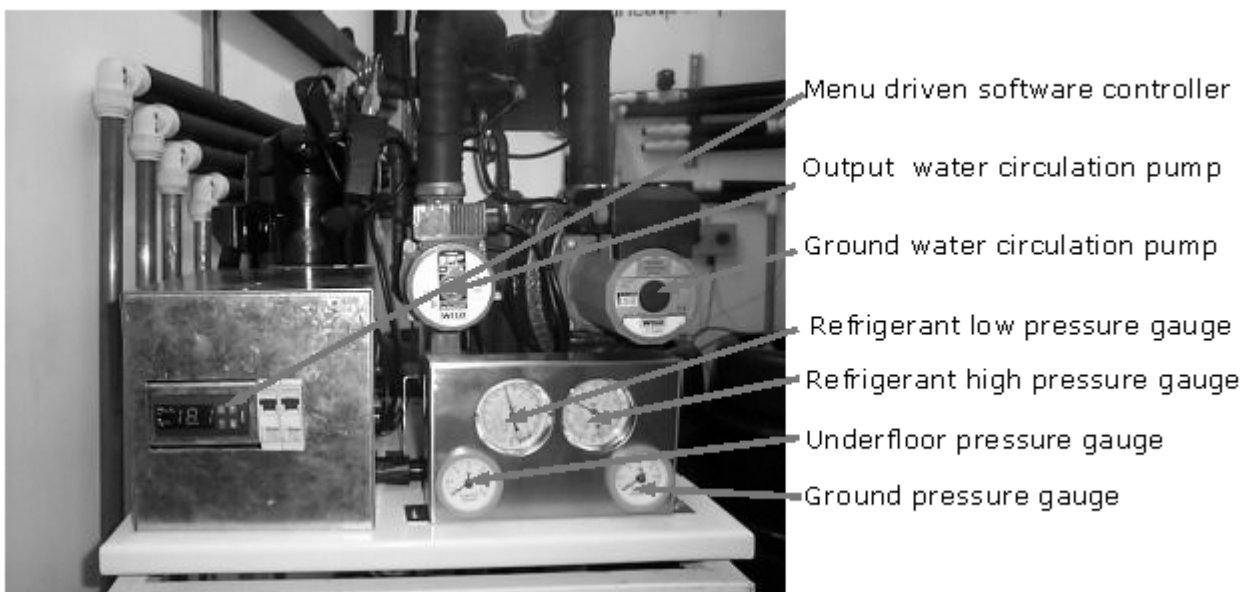



### **Microprocessor Controller**

The display normally reads the temperature of the water returning from the underfloor heating or radiator system. The microprocessor will turn the heat pump off once a pre-set temperature of water returning from the underfloor/radiators has been achieved. This setting is normally 30 deg C for underfloor applications, and 45 deg C for radiators applications. This is changed using parameter R3.

#### To read parameters : -

1. Press and hold the SEL button until r1 is displayed.
2. Press the UP arrow until r3 is displayed
3. Press SEL
4. The display will now show the return water setpoint temperature. Once this temperature is attained, the heat pump will switch off.
5. Press SEL
6. Press the UP arrow until r6 is displayed.
7. Press SEL
8. The display will now show the temperature of the colder water going out to the ground arrays
9. Press SEL
10. Press the UP arrow until r8 is displayed
11. Press SEL
12. The display will now show the temperature of the warmer water returning to the heat pump from the ground arrays

## **Microprocessor Alarms**

<b>Symptom</b>	<b>Probable Cause</b>	<b>Remedy</b>
<b>Display reads t1 with audible alarm</b>	Low water pressure in ground arrays or underfloor/radiators	Top up water in ground arrays or underfloor/radiators. Call plumber to find leak if this recurs
<b>Display reads H1 with audible alarm</b>	Heat pump overheating because there is no water flow to underfloor/radiators	Bleed left hand water pump, which serves the underfloor/radiators
<b>Display reads L1 with audible alarm</b>	Low temperature in ground arrays because of no water flow	Bleed right hand water pump. Call plumber to investigate.
<b>Display reads A1 with audible alarm</b>	Low temperature in ground arrays because of no water flow	Call Baxi and quote R6 and R8 temperatures

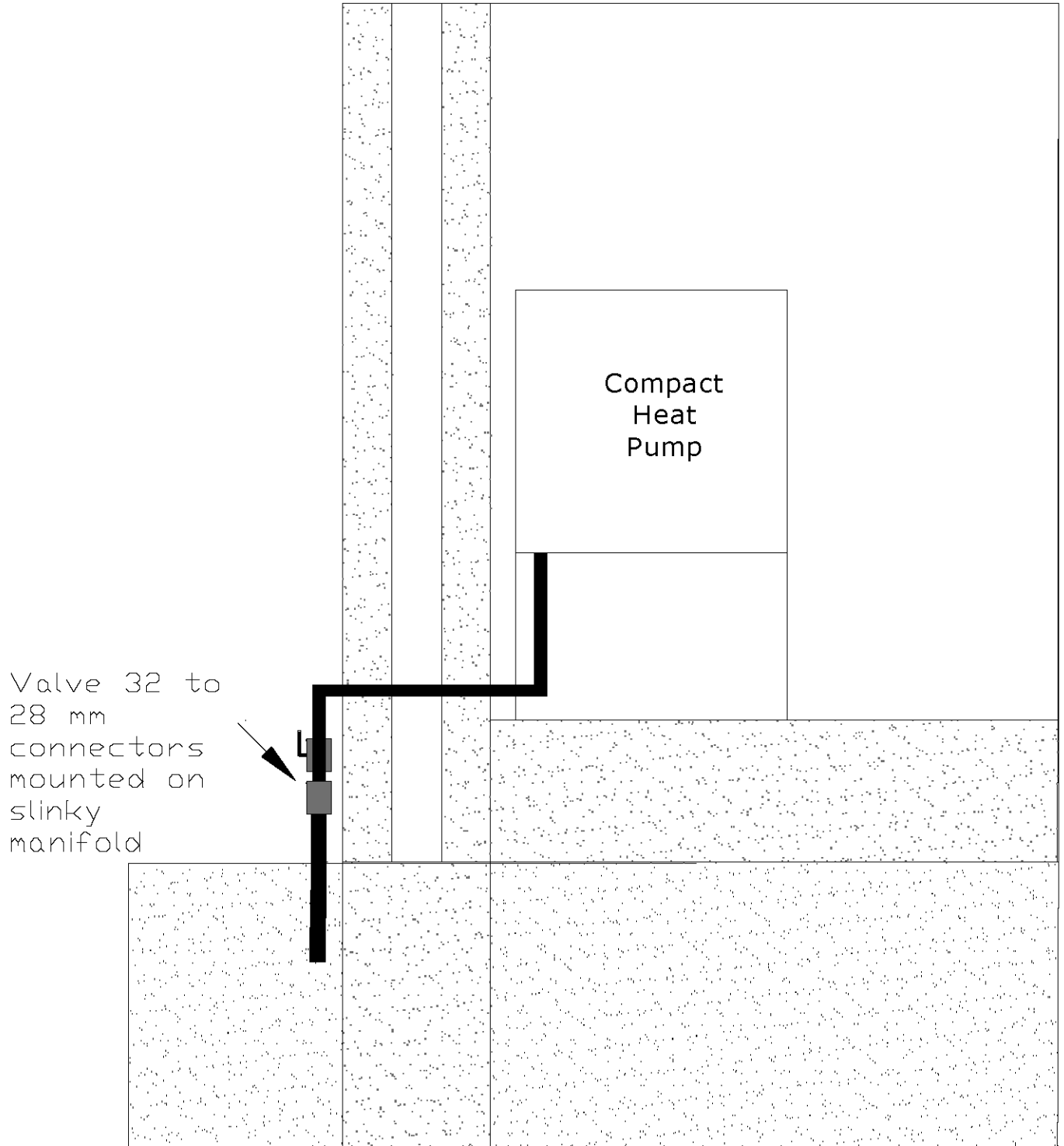



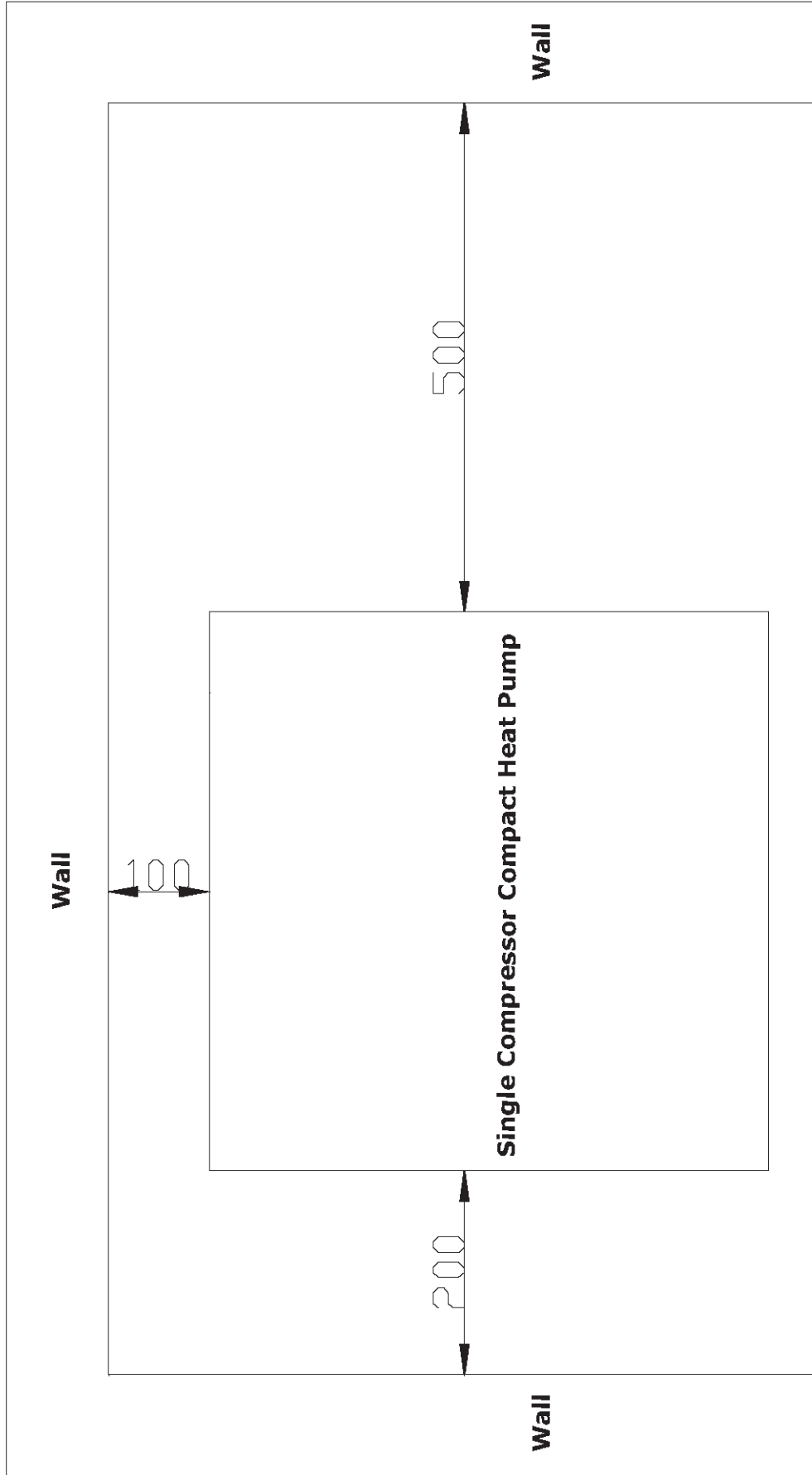

All dimensions in millimetres

## Single Compressor Compact Heat Pump Minimum Installation Clearances Plan View

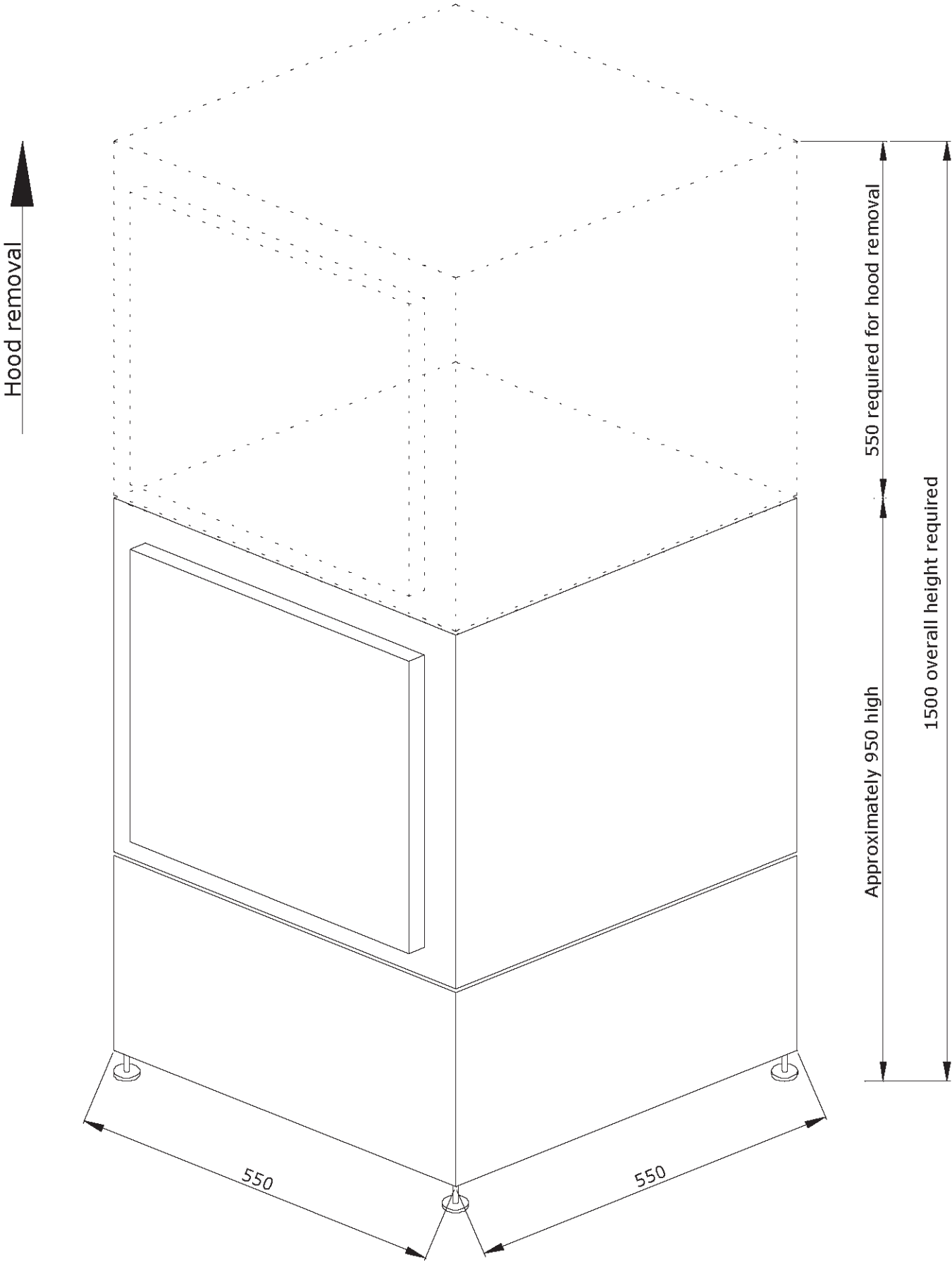

All dimensions in millimetres

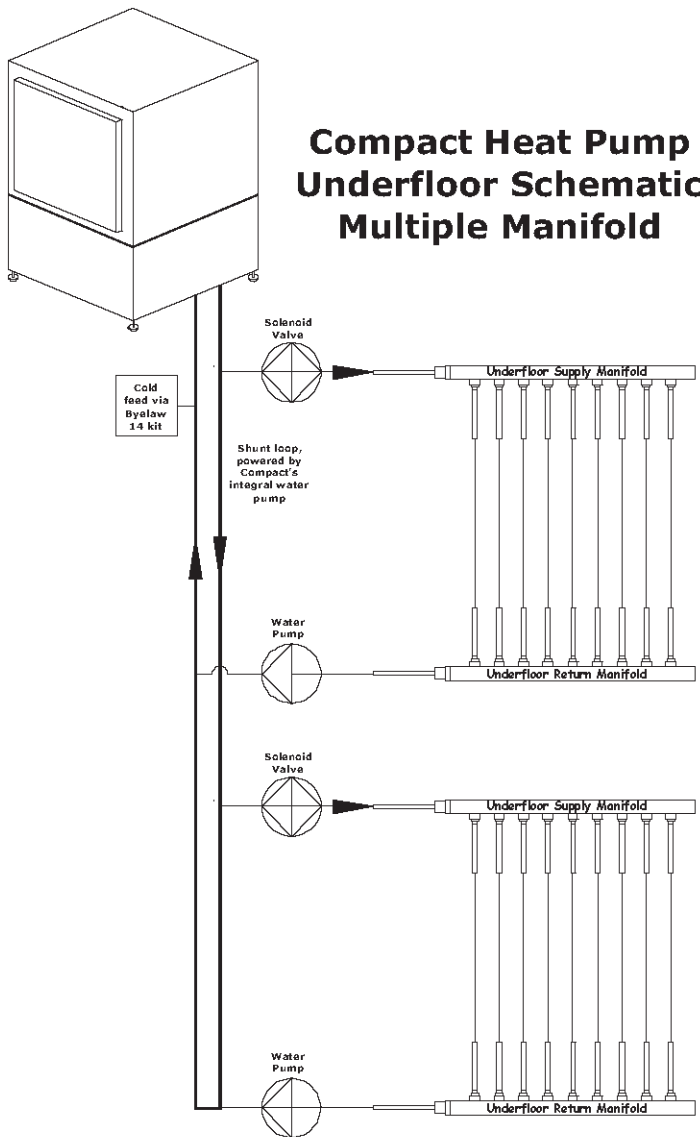
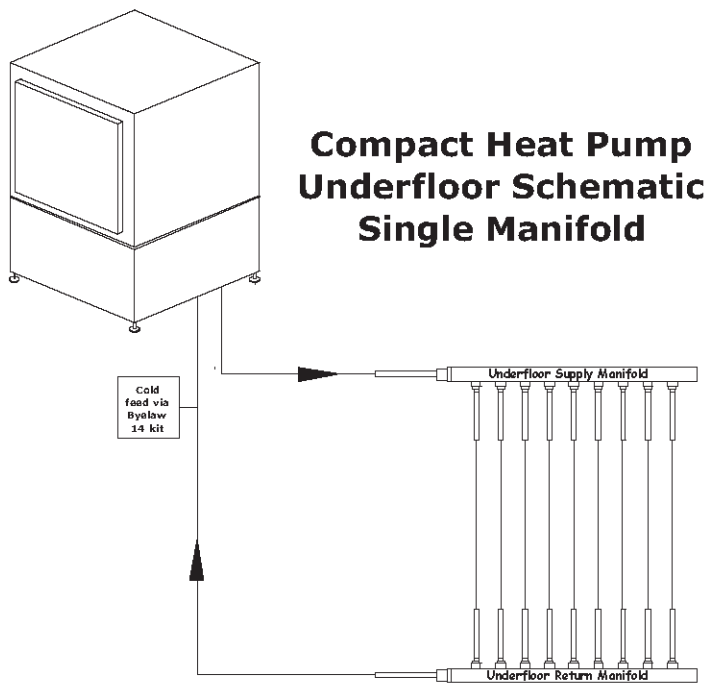

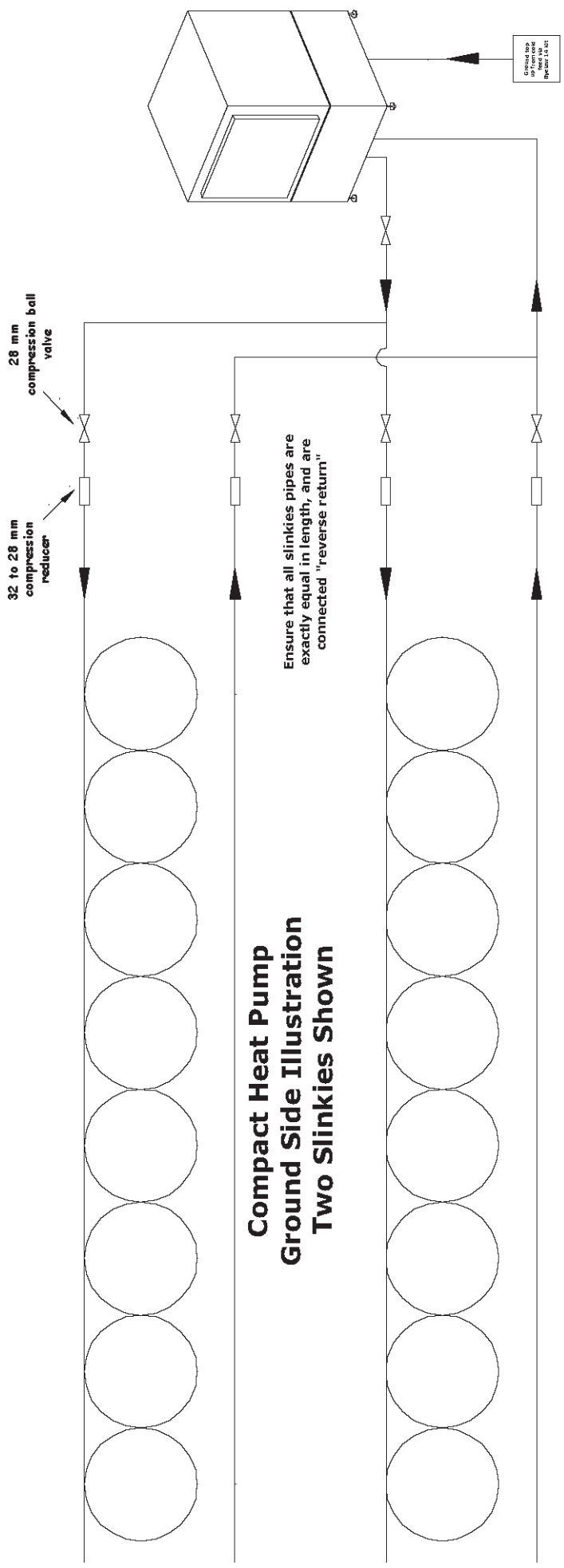

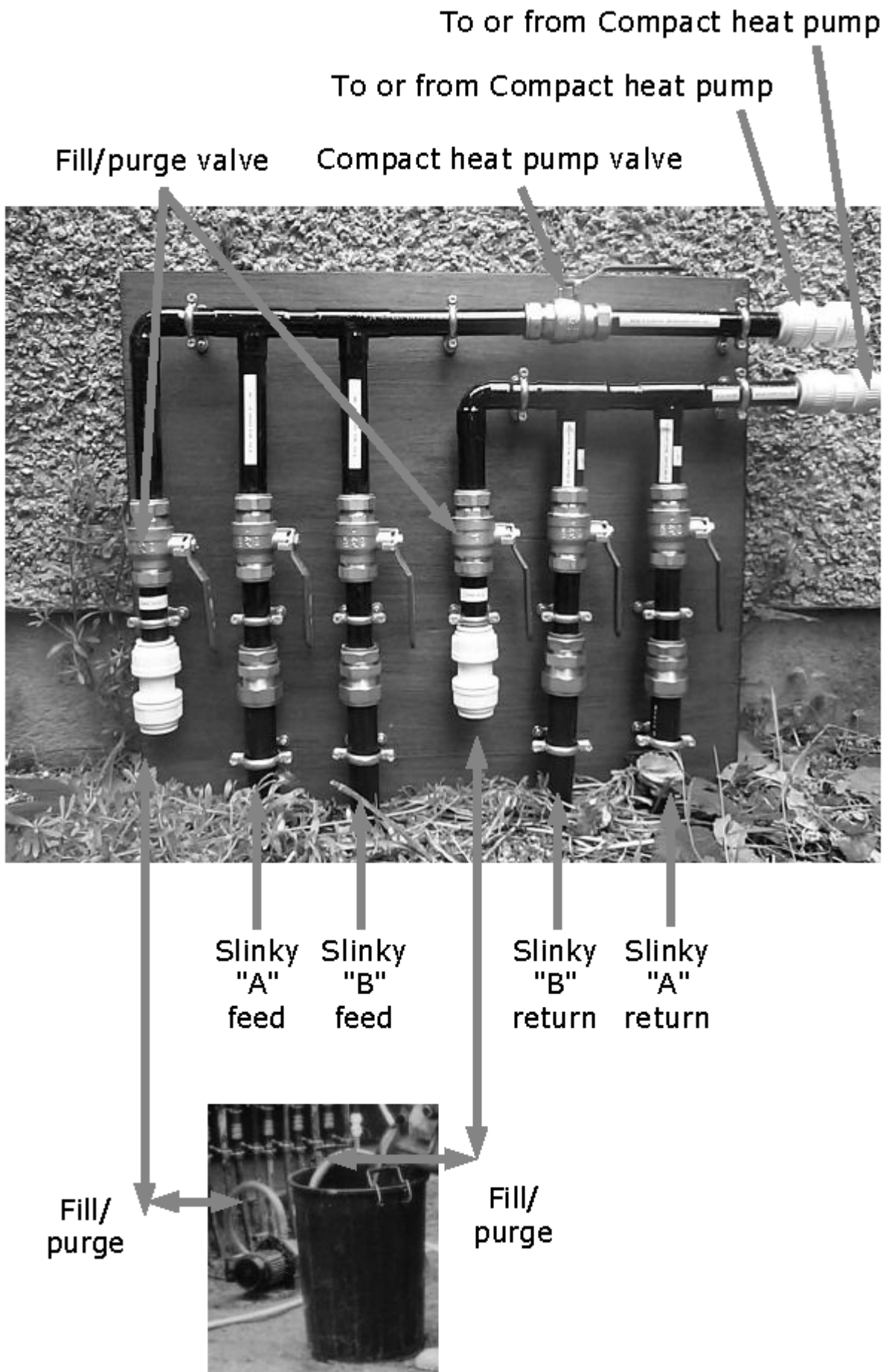

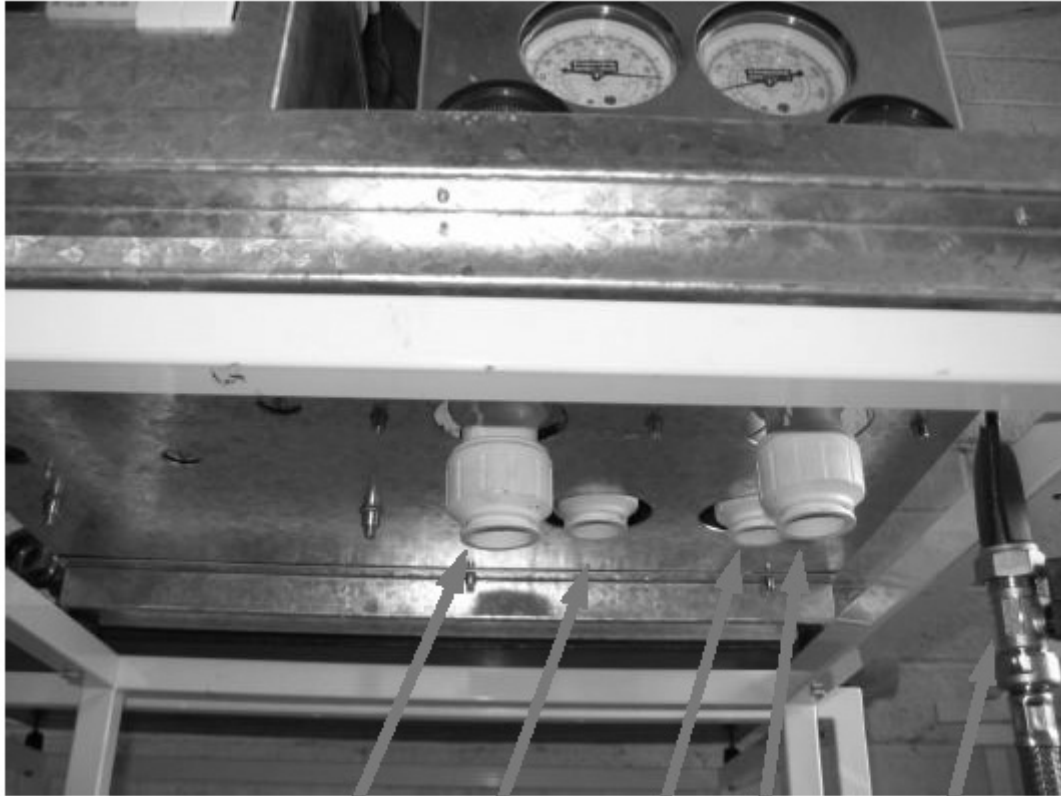

Underfloor  
supply  
28 mm

Underfloor  
Return  
28 mm

Return  
from  
ground  
28 mm

Supply to  
ground  
28 mm

15 mm  
cold feed

**All pipe connections to the heat pump  
must be in flexible plastic pipe**

Bleed port



## Purge Pumps

It is possible that difficulty may be experienced removing air out of the ground arrays, especially out of the top of each of the "Slinky®" loops which consist of a large number of 1 metre diameter loops of 1" bore pipe. This can also occur with vertical (ie. drilled) arrays. All procedures for removing air from slinkies® applies equally to removing air from underfloor heating systems. Most underfloor heating manifolds have fill/purge connections, and the same pump and procedure can be used for underfloor as for slinkies®.

### Why not just use mains water ?

A normal rising cold water main in a building has insufficient flow to force out this air - typical flow rates from a cold tap are around 10 to 30 litres per minute, which is less than half that required. Also mains water is "aerated".

### Why can't I use an existing pump that I have ?

To remove the air from Slinky® ground arrays, a suitable pump will be required. The longest slinky® trench is 50 metres, which will contain a total of about 300 metres of pipe. To achieve the minimum velocity through the slinky® pipes to remove the air, a minimum pump power in excess of 1 kW is required. If you are considering using an existing pump and it does not absorb at least 1 kW then it will not be suitable. In addition, the pump needs to have high-flow (at least 60 litres per minute) against a pressure of at least 1 bar. To achieve this, a "multi-stage" type of pump is needed, which is different to "normal" types of water pump.

### Where can I get hold of a suitable purge pump ?

We recommend the Clarke CPEI 30SS, part no. 051010379 from [www.machinemart.co.uk](http://www.machinemart.co.uk) or telephone 0845 450 2855. The pump comes ready to take a 1" BSP fitting. A plumbers merchant can supply a 2 x 1" BSP male iron to 28 mm compression. This will enable the pump to be connected to the slinky® manifold using 28 mm "Speedfit" or similar pipe and elbows.

### Any other tips ?

Before it will work, the pump itself needs to be purged of air by removing the fill plug, and filling with water, along with both connecting pipes. Fill the ground arrays with water as far as possible, and pressurise them with mains water using the cold-feed on the heat pump. Opening the valve between the slinky® manifold and the water pump will force water through the pump, into the dustbin, purging air out of the pump on the way. It usually takes around 2 to 3 minutes of pumping for water to go all the way through one slinky® and back to the dustbin. As the Clarke CPEI 30SS will achieve up to 5 bar pressure against a closed valve it is essential that the connections to the pump and manifold are robust.



Clarke CPEI 30SS  
Purge Pump



Slinky  
Manifold



In-line purge  
Pump

80 litre dustbin

Single Manifold (smaller building)

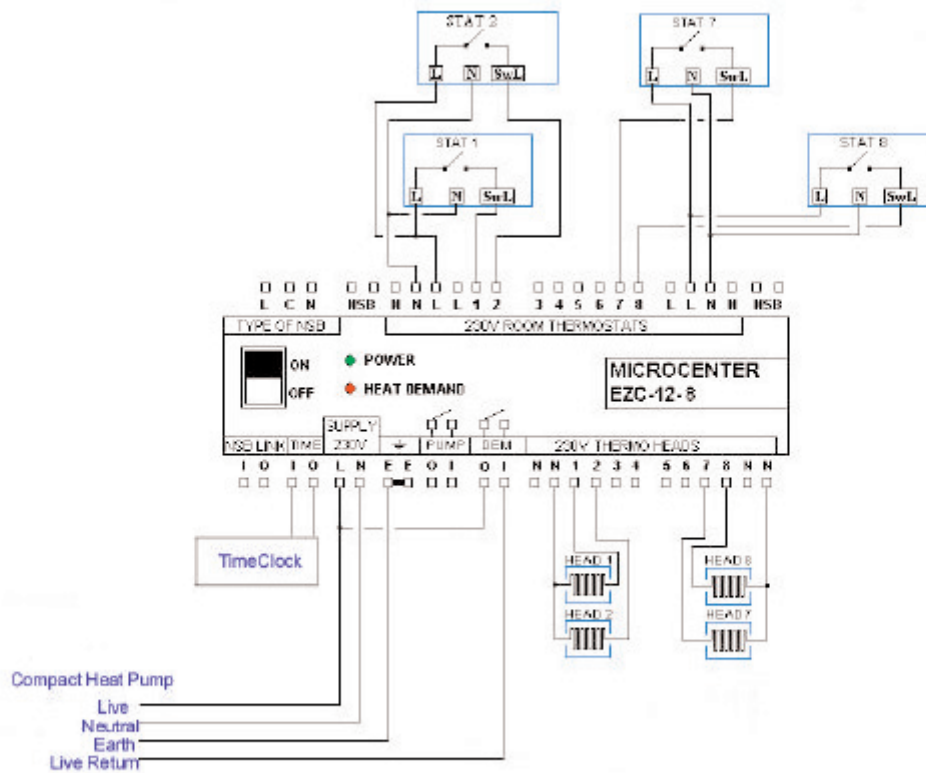

Multiple Manifold (larger building)

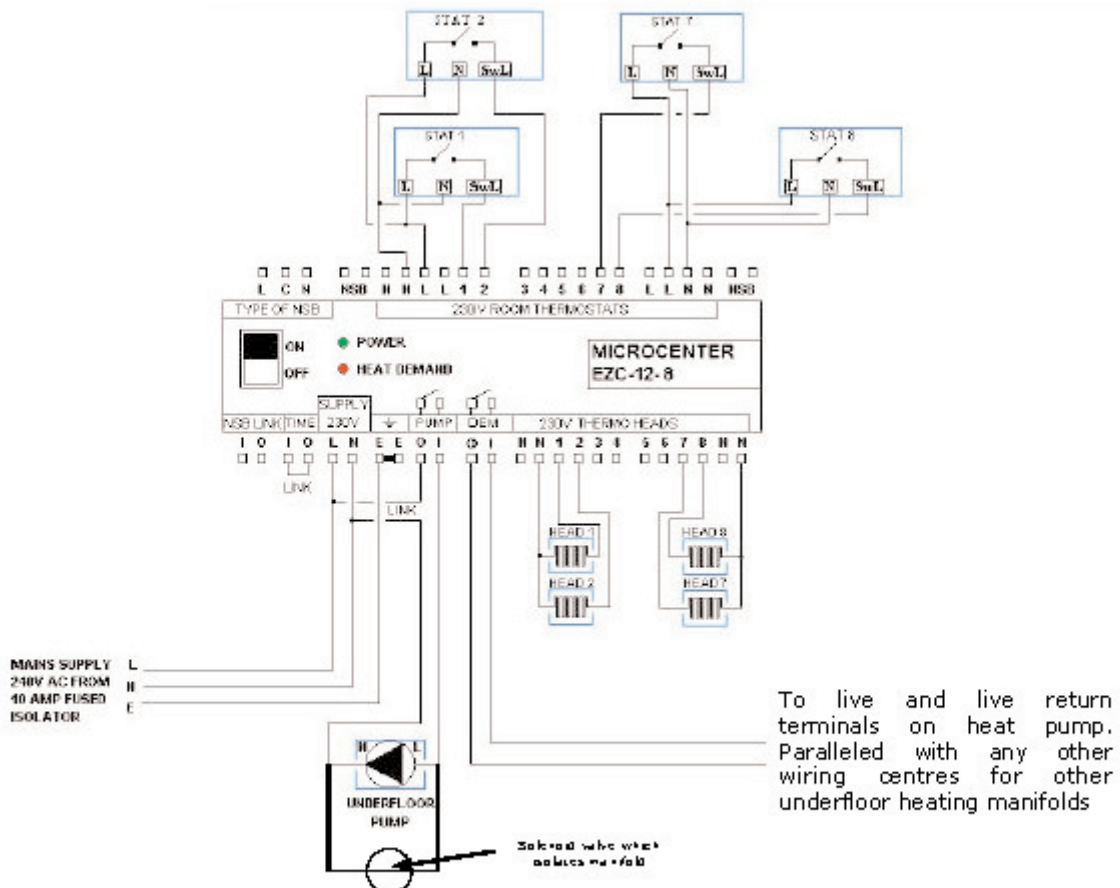

To live and live return terminals on heat pump. Paralleled with any other wiring centres for other underfloor heating manifolds

# Control Box Layout

Power supply connections

Enable signal connections

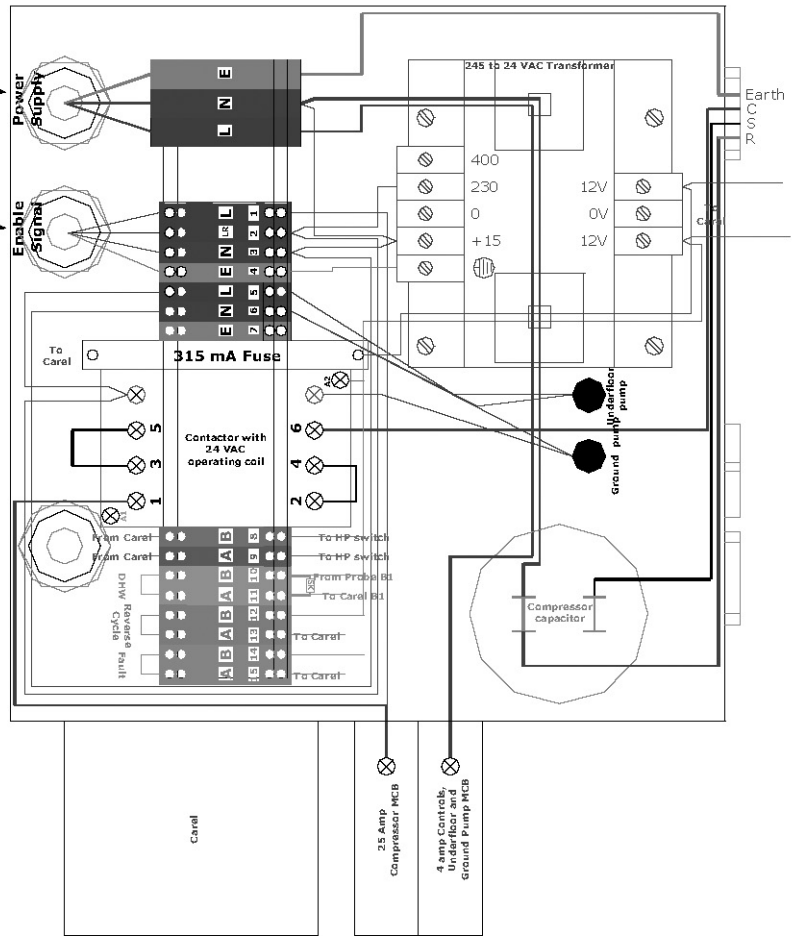

A "D" Type MCB must be used in the building's distribution board!

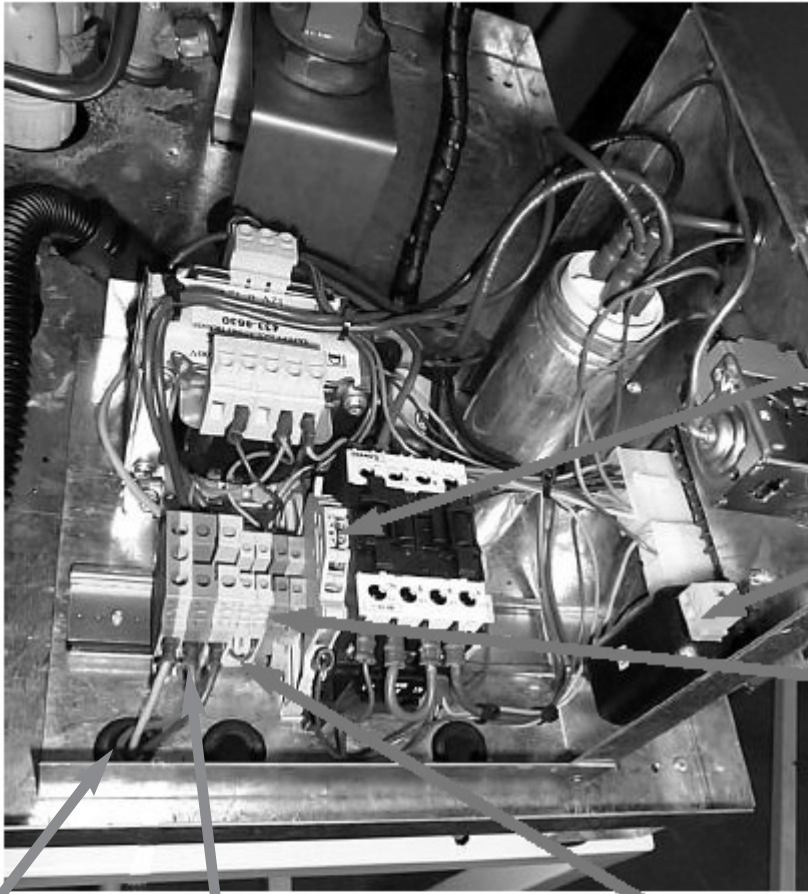

315 mA fuse  
for software  
controller

Weather  
compensation  
sensor  
connections

Timeclock/  
Thermostat  
connections

Gland nut for  
power supply

Power supply  
connections

**NB. Timeclock/Thermostat connection is  
supplied with a temporary link across it.**

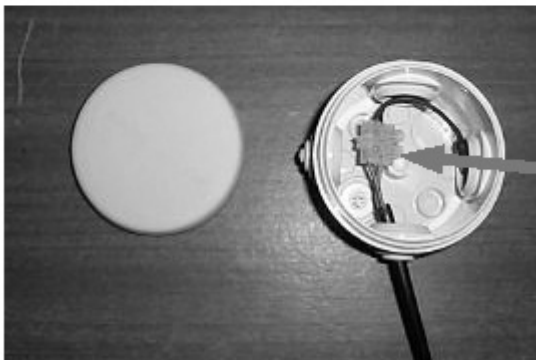

Weather compensation  
sensor connections

## Compact Heat Pump Installation Instructions

### The installation must be performed by a competent person.

1. Decide on a suitable location for the Compact. The back of a domestic garage, or a utility room is recommended. It should not be placed in any inhabited space. The Compact emits limited noise and vibration, and should not be placed adjacent to, or below bedrooms. Take into account the "Recommended Clearances" when finalising the location.
2. Remove the door by turning the lock with a screwdriver, opening and lifting off.
3. Remove the hood by unscrewing the 5 mm hex key screws on either side of the base of the hood. Carefully lift the hood off, which may require two people.
4. Remove all three lower closure panels necessary to gain access to the pipe connections, by unscrewing the 4 x hex-headed stainless steel screws on each panel.
5. Place the Compact in position and level it using the adjustable feet if necessary. Tighten the locking nuts on the feet when level.
6. Ensure the underfloor heating system has been thoroughly purged of any debris.
7. **Using only plastic flexible pipe such as Speedfit®** connect the cold feed, ground feed & return pipes from the Slinky® Manifold (which can be connected either way round), feed & return pipes from the underfloor heating manifold (which must be connected the correct way round), according to the Plumbing Connections Illustration. Flexible pipe must be used as the heat pump is suspended on anti-vibration mounts, so any connections must also be flexible.

**NOTE:** All external wiring, including the power supply and any control wiring, must be correctly earthed, polarised and in accordance with relevant regulations/rules. In GB this is the current I.E.E. Wiring Regulations. In IE reference should be made to the current edition of ETCI rules. Power supplied must be terminated in a D type MCB at the distribution board. The fuse should be sized according to the power rating as shown in the table on page 5. The mains supply is 230V ~ 50Hz. The method of connection to the electricity supply must facilitate complete electrical isolation of the appliance. Connection may be via a fused double-pole isolator with a contact separation of at least 3mm in all poles and serving the appliance and system controls only.

8. Thread the power supply and timeclock/room thermostat wires from under the Compact into the control box and connect them to the terminals required (see "wiring connections" illustration). The power supply must be routed through the gland nut.
9. Fit the weather compensation sensor on a North facing wall, and connect with two-core minimum 0.5mm sq cable to the connections in the control box (see "wiring connections" illustration). The wires can be connected either way round. Avoid routing this cable with any other cables to prevent interference.
10. Check and rectify any leaks that may be in the plumbing system.
11. Remove the plastic blanking plugs, and connect the purge pump to the fill and purge ports on the Slinky® Manifold (see "Purging the ground arrays"). Keep the isolating valve to the heat pump closed. The purge ports can be connected either way round.
12. Connect the purge pump to suck from an 80 litre container (such as a dustbin) half filled with clean water. The pump must be capable of moving around 60 litres per minute against a pressure of approximately 1 bar. If the pump's electrical rating is less than 1 kW, then it is unlikely to be suitable. The water level in the container will need to be topped up constantly during the following process. The pump may need priming by pouring water into its priming port until it overflows. Open the flow and return valves to one slinky®, and ensure that the others are closed, and the valve to the heat pump is also closed. Open the fill and purge port valves (see "Purging the ground arrays").
13. Place a filter such as a kitchen sieve over the end of the pipe that returns water to the container so any debris will be captured. Start the purge pump, being careful that the pipe returning water to the container does not splash or whip round and cause any injury.
14. Water should now be being pumped from the 80 litre container and into one of the slinkies®. If the water level in the container does not go down, then pump priming should be repeated. No water should be flowing through the heat pump or through the other slinky®. The flow rate should be significant, usually in excess of 30 litres per minute. This can easily be checked by holding a 10 litre bucket to collect water returning from the slinky®, and ensuring that it fills the bucket in less than 20 seconds. If the flow is less than this sufficient velocity for the air in the tops of the slinkies® to be displaced is not being achieved. Purge each slinky® for at least 10 minutes.

15. After water has circulated for approximately ten minutes, and no more debris has collected in the sieve, the valves on the first slinky® can be closed and the valves opened on the other slinky®, again being careful that the return pipe into the container does not whip round and cause any injury. At this stage, the valve to the heat pump should still be closed.
16. After another ten minutes, once no more debris has collected in the sieve, go on to any other slinkies® in turn. When all the slinkies® have been purged, the valve to the heat pump can be opened, which will purge the heat pump of air - this is likely to occur very quickly, and great care should be taken that the hose discharging into the container does not whip around.
17. Repeat the above procedure, placing the return hose from the slinky® manifold under water in the container until that there are no more bubbles of any kind.
18. Once you are certain that you have circulated water around all the slinkies®, and there is no more air left in the entire ground array system or the heat pump, pour antifreeze into the container (it may be necessary to remove some water first) and repeat the procedure, to ensure that all the antifreeze has mixed thoroughly through to all the slinkies® and to the heat pump.
19. Close the fill and purge valves on the slinky® manifold with the pump running, shutting the return valve last so that the slinky® is left under pressure.
20. The system should remain pressurised at above 1 bar and can be checked for leaks; the pressure will slowly fall as the pipes in the ground arrays slowly expand in the coming months, and may need topping up using the cold fill system provided. Most purge pumps will usually attain around 5 bar, and it is quite acceptable to leave the circuit at this pressure, so that any leaks will immediately become apparent.
21. In order to activate the software controller, both the ground and underfloor circuits must be taken above 1.8 bar water pressure.
22. Remove the purging equipment, and the handles from the valves on the manifold to ensure they cannot be inadvertently operated, and place the plastic blanking plugs back in the slinky® manifold.
23. Find the cold fill for the underfloor heating system and open the valve to allow water into the underfloor system and the Compact.
24. Remove the cap from the Output Pump Bleed Port and depress the schrader valve using a small screwdriver, as shown in the "Output pump bleed port" illustration. Alternatively, the schrader valve core can be unscrewed completely using a car tyre valve core remover and a 10 mm internal diameter plastic pipe placed on the outside of the valve to allow any water or air to be vented into a bucket.
25. When a solid stream of water comes from the valve the pump will be bled. This procedure needs to be repeated at intervals during the commissioning procedure if there is any air in the underfloor system, which is highly likely. Place the cap back on the Output Bleed Valve .
26. Turn the power on to the heat pump. The display will read the temperature of the water returning from the underfloor / radiators. If error t1 is displayed, then the heat pump will not run until both underfloor/radiator and ground circuits are at about 2 bar pressure.
27. Enable the heat pump, and make sure the impellers in both ground and underfloor/radiator water pumps are turning by removing the stainless steel screws in the centre of each water pump and inserting a flat-bladed screwdriver.
28. Please call Baxi so that the Commissioning Sheet can be completed.
29. Replace the three closure panels by screwing in the 5 mm hex key screws on the front of the Compact. Carefully lift the hood back onto the Compact, which may require two people. Screw in the 5 mm hex key screws on either side of the base of the hood. Replace the door and lock it shut.



All descriptions and illustrations provided in this leaflet have been carefully prepared but we reserve the right to make changes and improvements in our products which may affect the accuracy of the information contained in this leaflet. All goods are sold subject to our standard Conditions of Sale which are available on request.

**Baxi Heating UK Ltd**  
Brooks House, Coventry Road, Warwick. CV34 4LL  
After Sales Service and Technical Enquiries 08700 603 261  
Website [www.baxi.co.uk](http://www.baxi.co.uk)  
e&oe

A BAXI GROUP company