

Solar Collectors

Please read these instructions before installing or commissioning.

This Solar Thermal Domestic Hot Water System should only be installed by a competent person.

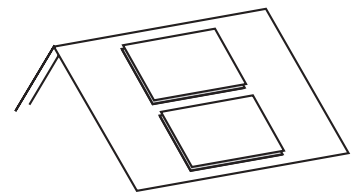
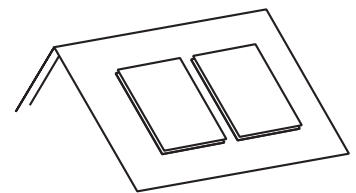
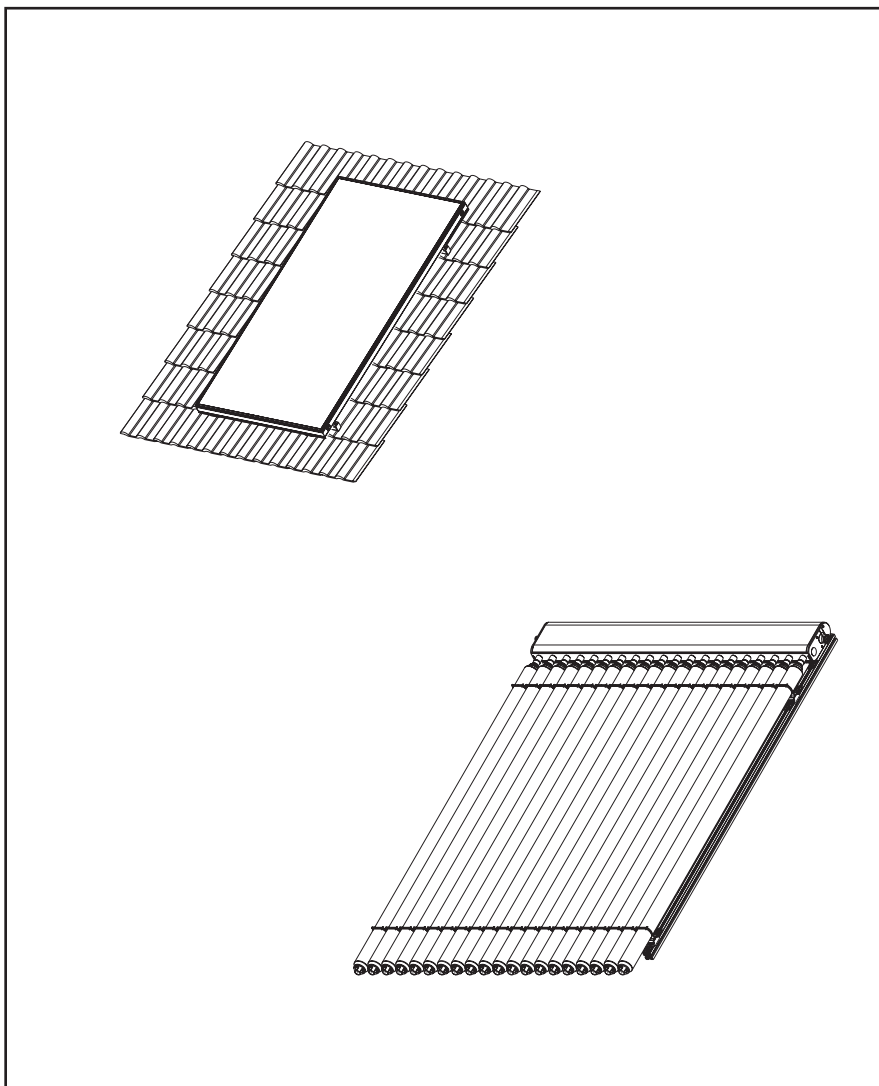

Please leave these instructions with the User

1.1 Information

When your Solar domestic water heating system was installed the installer should have fully commissioned the system and left it in working order. Following this they should have explained the system, its function and control including:

Heating by solar

Explained how the cylinder is heated when there is sufficient solar energy.

Heating by auxiliary heating source

Explained how the cylinder is heated if additional heat input is required due to insufficient solar energy being available (little or no sun) or additional quantities of hot water are required.

Operation of the Solar Controller

Explained the icons and their meanings displayed at the controller.

System Malfunction

Explained what to do in the event of a system fault including how to isolate the electrical supply or water supply.

System Maintenance

Explained the necessity for the system to receive regular maintenance to ensure its continued safe and efficient operation.

Literature

The Commissioning Record (see 2nd Fix Manual) should be completed and left with the user.

These instructions explain a number of the above points and should be retained as a reminder of how to operate the Solar Water Heating System.

If you are in any doubt, please ask your installer for clarification or contact the Baxi Technical Enquiry Line, Telephone 0844 871 1555.

Serial Number

The appliance serial number is situated at the rear of the right hand side of the solar pump station and the model name is on the front face of the solar temperature differential controller. These should be quoted when contacting the Baxi Technical Enquiry Line.

© Baxi Heating UK Ltd 2011. All rights reserved. No part of this publication may be reproduced or transmitted in any form or by any means, or stored in any retrieval system of any nature (including in any database), in each case whether electronic, mechanical, recording or otherwise, without prior written permission of the copyright owner, except for permitted fair dealing under Copyrights, Designs and Patents Act 1988.

Applications for the copyright owner's permission to reproduce or make other use of any part of this publication should be made, giving any details of the proposed use to the following address:

The Company Secretary, Baxi Heating UK Ltd,
Brooks House, Coventry Road, Warwick. CV34 4LL

Full acknowledgement of author and source must be given.

WARNING: Any person who does any unauthorised act in relation to a copyright work may be liable to criminal prosecution and civil claims for damages.

2.1 Description

Your Solar system consists of several component parts that work together to heat your domestic hot water supply either from the power of the sun, by conventional means (by a boiler or electric immersion heaters) or combination of both. This combination is required because the sun's energy is not uniformly received throughout the year (some 70% of the UK's annual radiation is received over the period April to September). The amount of sunshine hours will vary and the proportion of direct radiation (from a clear sunny day) and diffuse radiation (from partly cloudy or overcast skies) will also vary. However, on average up to 60% of a dwellings annual hot water requirement can be provided by a solar water heating system. The balance is provided by the auxiliary heating source.

Fig 1 shows the main component parts of the Baxi Solar System (unvented system).

- 1 Solar Collector
(Note: larger cylinders may have 2 or 3 collectors connected)
- 2 Solar Pump Station
- 3 Solar Controller
(Note: May be mounted remotely from Pump Station)
- 4 Solar Expansion Vessel
- 5 Solar Cylinder
- 6 Baxi Boiler Auxiliary Heating Source
(Note: Auxiliary heating may be by immersion heaters)
- 7 Solar Cylinder cold water controls
(Note: May not be fitted if using a cistern fed vented cylinder eg. Heatrae Sadia Megaflo)
- 8 Thermostatic blending valve
- 9 Balanced cold water supply (Accessory)
- 10 Energy Productivity Meter (Accessory)
- 11 Combi Valve with balanced supply outlet

Fig. 1 Unvented System Example

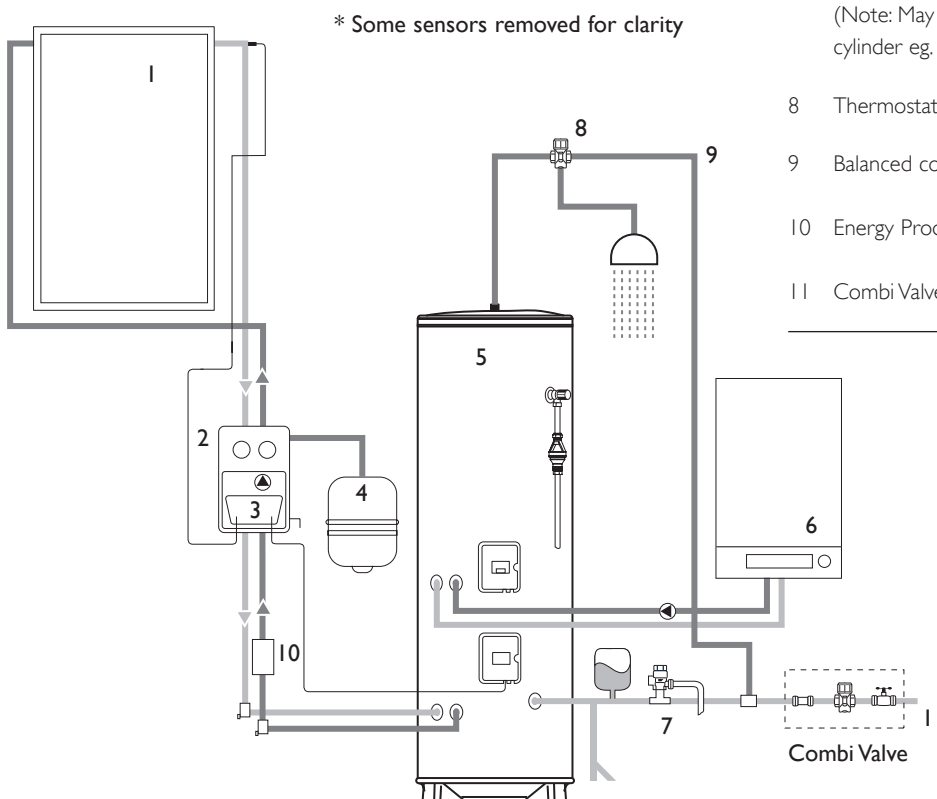

3.1 Operating Settings

Generally the operating settings of your domestic solar hot water heating system will have been set up by your installer. For the system to operate correctly and efficiently these settings should not be altered. Section 4 details the user controls which your installer should familiarise you with during commissioning the system.

If in doubt contact a qualified solar installation engineer, alteration of some settings could adversely affect the operation of the system.

As with any heating system there are certain aspects that will require regular checking and/or maintenance. Section 6 details what these should be. Any maintenance or servicing should only be carried out by qualified personnel and be recorded in the Commissioning Maintenance and Servicing Guide supplied with the system.

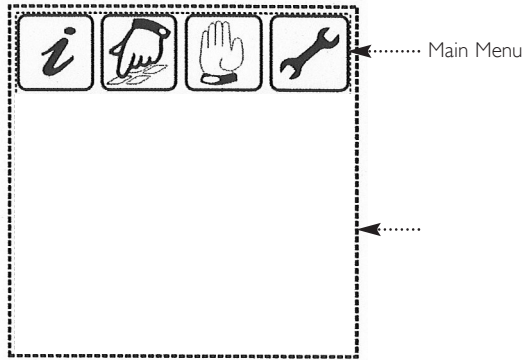

Display Screen

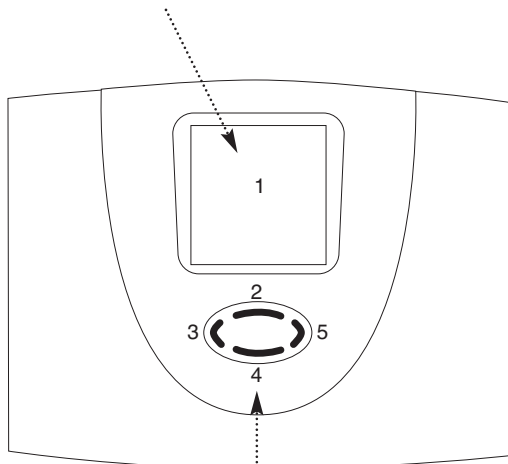

Control Button

- 2 Scroll upwards
- 4 Scroll downwards or select required main menu
- 3 Scroll left or exit to main menu
- 5 Scroll right or select to edit function

Example Screen - Programming Menu

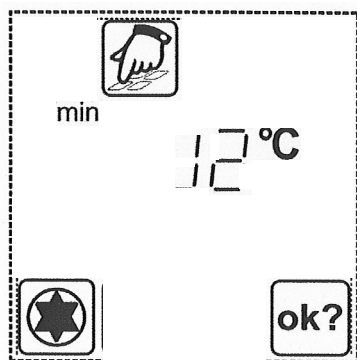

4.0 User Controls

4.1 Main Menu

To make the operation of the controller clear, operating and display functions are divided into 4 main menus.

- Info Indication of current measured values.
Indication of system condition.
Indication of error messages.
Indication of operating hours and energy productivity (if installed).
- Programming Changes to programmable values (parameters).
- Manual operation This menu is for the installation engineer only.
- Basic adjustment This menu is for the installation engineer only.

It is not intended that the householder should attempt to programme the operation of the system so various parts of the programming menu are not reproduced here. For further information on programming the Solar Differential Controller refer to the 2nd Fix Manual.

NOTE: Altering some settings could adversely affect the operation of the solar system. If in doubt contact a qualified solar installation engineer. Alteration of functions not covered in this user guide will invalidate the warranty.

Each active menu is shown in the upper line of the display by its corresponding icon.

4.2 Control Button

When in the Main Menu the control button functions are as follows:

- Item 2 - Scroll upwards- no function in this menu
- Item 3 - Scroll left - moves left through the main menu options
- Item 4 - Scroll down - selects the menu option currently flashing and gives access to the sub-menu
- Item 5 - Scroll right - moves right through the main menu options

Once the sub-menu has been accessed, the flashing symbol becomes static and the button functions are then as follows:

- Item 2 - Scroll upwards- moves up through the available functions of the sub-menu
- Item 3 - Scroll left - return to main menu
- Item 4 - Scroll down - moves down through the available functions of the sub-menu
- Item 5 - Scroll right - select to edit the function displayed. The selected function will flash if it is available for editing. Use 2 to increase the required value and 4 to reduce it. Use 5 to OK.

4.0 User Controls

4.2 Menu "Info"

In this menu mode all measured values and operating states are shown.







If the values are marked as "reset possible", they may be reset in the following way:

Choose the value with buttons  and 















Reset value by means of the button 

Message "OK?" confirm with  = no or  = yes



Press  or  to scroll up or down to the required sub function. The icon will flash, press  to select the function. Reset by pressing  or  for increase/decrease values. Press  and **ok?** appears, press  to confirm and **ok?** disappears.

Example of Screen Display

Indication		Description	Reset possible
75°C		Indication of current collector temperature	no
min. 12°C		Indication of minimum collector temperature Re-settable to current temperature	yes
max. 105°C		Indication of maximum collector temperature Re-settable to current temperature	yes
52°C		Indication of current temperature storage tank (lower)	no
min. 40°C		Indication of minimum temperature storage tank (lower) Re-settable to current temperature	yes
max. 65°C		Frost protection or common measuring point	yes
25°C		Indication of universal temperature measuring points (T3)	no
55°C		Indication of current temperature storage tank thermostat	no
60°C		Indication of current temperature collector return	no
60°C	 	Indicates Auxiliary Heating Coil Temperature T6	no
1234 h		Operating hours for charging storage tank Resettable to 0 h	Yes
927 kWh		Energy productivity for storage tank (where applicable) Resettable to 0 kWh	Yes

4.0 User Controls

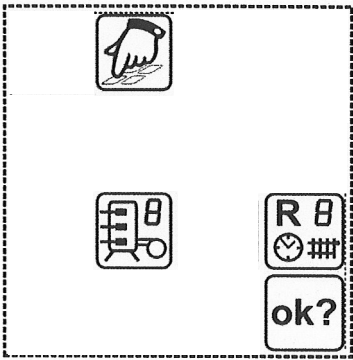









Press or to scroll up or down to the required sub function. The icon will flash, press to select the function. Reset by pressing or for increase/decrease values. Press and appears, press to confirm and disappears.

4.3 Menu "Programming"









All adjustable parameters can be checked in this menu and, if necessary, changed. The default factory setting will usually give efficient and problem free operation. However Baxi recommend the following parameters marked * must be left at the default settings. Any change to the Baxi recommended settings will invalidate the warranty.

Indication		Description	Value range	Defaults
max 65°C		Storage 1/2: Maximum temperature	15..65°C	65°C *
dT max 7 K		Storage 1/2: Hysteresis (dT on) *	3..40 K	7 K
dT min 3 K		Storage 1/2: Hysteresis (dT off) *	2..35 K	3 K
min 100		Setting the speed control of the pump 100% = speed control off	30%..100%	100%
min 40°C		Temperature start for the function heating	20..90°C	40°C
dT 10K		Hysteresis heating	1..30K	10K

* Temperature lag between switch on and switch off

Status indication		
	Solar circulation pump	Symbol revolves when solar circulation pump is on
	Switch output 1 is active	Appears when switch output 1 is active (on)
	Switch output 2 is active	Appears when switch output 2 is active (on)
	Switch output 3 is active	Appears when switch output 3 is active (on)
	Reference to system fault	Display flashes when a fault occurs in the system
	Safety query for value changes which are to be stored	Input value can be either  rejected or  accepted

The controller will display certain information in the event of some system faults. The following table indicates these and will aid in describing the nature of the fault to the Service Engineer. **DO NOT attempt to rectify faults yourself**, contact Technical Enquires on 0844 871 1555 or a qualified Solar water heating engineer.

Error representation on display	Possible reasons
  flashing	<ul style="list-style-type: none"> • Sensor wire broke • Sensor defect
  flashing	<ul style="list-style-type: none"> • Short circuit in sensor wire • Sensor defect
Circulation error: no flow  +  flashing	<ul style="list-style-type: none"> • Error in pump connection • Pump defect • Air in the system
Additionally at energy productivity measurement: 	<ul style="list-style-type: none"> • Connection with flow meter defect • Sensor wire broken • Sensor defect
	<ul style="list-style-type: none"> • Go back through menu to identify fault or contact Technical Enquires

5.0 Important Notes

If the system pressure falls to zero, switch off the power supply to the Solar Controller and contact a qualified solar heating engineer.

Familiarise yourself with the controls and instructions supplied with the Solar Cylinder and follow manufacturer's instructions in the event of a cylinder fault.

The pipework between the solar collector(s) and the solar cylinder can be very hot. These pipes should have been insulated by the installer. This is high temperature insulation. In the event of damage contact Technical Enquiries.

If the electrical supply for the Solar domestic hot water heating system is interrupted it will not operate. However, programme settings are stored by the controller and should not need resetting when power is restored.

The Solar Controller may have been integrated with the auxiliary heating controls to optimise the solar gain from the system and minimise the use of the auxiliary heat source. Your installer should explain how the system will function in this event. The Solar Controller will not control the space (central) heating system, separate controls are necessary for this function. Refer to the instructions supplied with any separate auxiliary controls for details of their correct setting.

6.0 Servicing and Maintenance

To ensure the continued safe and efficient operation of your Solar Water Heating System, it should regularly be checked and maintained by a qualified engineer. It is recommended that checks be carried out on an annual basis in accordance with the maintenance requirements detailed in the 2nd Fix Manual. Additionally the concentration of the solar thermal transfer fluid should be checked and if necessary topped up or replaced every 2 years. Failure to maintain the system may invalidate your warranty.

For warranty Terms and Conditions please refer to the 2nd Fix Manual.

All descriptions and illustrations provided in this leaflet have been carefully prepared but we reserve the right to make changes and improvements in our products which may affect the accuracy of the information contained in this leaflet. All goods are sold subject to our standard Conditions of Sale which are available on request.

MULTIFIT

A Registered Trademark of Baxi Heating UK Ltd (3879156),
Brooks House, Coventry Road, Warwick. CV34 4LL
Technical Enquiries 0844 8711555
Website www.baxiheating.co.uk
e&oe

PART OF BDR THERMEA

Comp No 720598101 (2/11)